

# Material Characterization of 3D Printing Polymers Using Pyrolysis-GC/MS



## Why Pyrolysis GC/MS?

**Manufacturers are always seeking new technologies and developments that increase production efficiency and the quality of the produced parts.**

Many analytical protocols used to analyze 3D printing and coating components require multi-step sample preparation prior to chromatographic analysis. These procedures often include solvent extraction, filtration, and concentration. These traditional techniques are cumbersome, time-consuming, and suffer from analyst-to-analyst variability while producing data of limited value.

Samples are analyzed “as is” when using the Frontier pyrolyzer. No sample preparation is needed. Eliminating the solvent extraction process enhances the precision of quantitative analysis while virtually prevent sample contamination and improves analytical efficiency. These are three of the primary reasons many manufacturing and polymer development laboratories utilize the Frontier Pyrolyzer.

The Frontier Multi-Shot Pyrolyzer can be configured in a number of different ways, so that a sample can be characterized using various analytical techniques, including evolved gas analysis, thermal desorption, flash pyrolysis, double-shot, Heart-Cutting of individual EGA thermal zones, and reactive pyrolysis. Initially, such diversity may be perceived as a complicated decision process: what analytical mode will give us the most insight into the nature of the sample in the least amount of time? To assist, Frontier scientists have created a “method map”. An overview of the “method map” is provided on page 45.



## Table of Contents

Poly(lactic acid) (PLA) for 3D Printing	<a href="#">4</a>
Epoxy Adhesives and Resins as Thermosets	<a href="#">8</a>
Polysiloxane - PDMS and Adhesive Compositions	<a href="#">12</a>
Polyphenylene Ether (PPE) Plastic Resins	<a href="#">16</a>
Polyphenylene Sulfide (PPS) Resins and Filaments	<a href="#">20</a>
ULTEM or Polyetherimide (PEI) High Performance Polymer	<a href="#">23</a>
Polyetheretherketone (PEEK) High Performance Polymers	<a href="#">26</a>
Nylon 12 Powder Resins and SLS 3D Printing	<a href="#">29</a>
Polycarbonate (PC) Plastic Resins	<a href="#">32</a>
Nylon 6 and Polyphenylene sulfide (PPS) Blended Polymers	<a href="#">35</a>
Thermoset Polymer Resin Coated Proppant	<a href="#">38</a>
What is Pyrolysis GC/MS Technique?	<a href="#">42</a>
Simplify and Improve Data Interpretation by F-search	<a href="#">44</a>
“Method Map” Providing Direction	<a href="#">45</a>
Pyrolysis-GC/MS System Configuration	<a href="#">47</a>

# Polylactic acid (PLA) for 3D Printing

**Background:** There is a high interest in bio-derived Plastics. Polylactic acid or polylactide (PLA or PLLA) is a thermoplastic polyester derived from renewable biomass (monomer) from fermented plant starch such as corn, cassava, sugarcane or sugar beet pulp. They range from amorphous glassy polymer to semi-crystalline and highly crystalline polymer with a glass transition temperature ( $T_g$ ) of 60 °C and melting points of 130-180 °C. It is one of the most produced bioplastics. The mechanical properties of PLA are between those of polystyrene and PET. The melting temperature,  $T_m$ , of PLA can be increased by 40–50 °C and its heat deflection temperature can be increased from approximately 60 °C to up to 190 °C by physically blending the polymer with PDLA (poly-D-lactide). Polylactic acid can be processed like most thermoplastics into fiber (for example, using conventional melt spinning processes) and film. With high surface energy, PLA has easy printability which makes it widely used as a filament in 3-D printing.

**Problem:** Although PLA is commonly used as a 3D Printing polymer filament material, the composition in most filaments is unknown, including the presence of PDLA or any compatible additives or modifiers. While IR spectroscopy can be used for screening, it is not sufficient for composition determination or distinguishing between other types of polyester blends or PLA sources.

**Solution:** Using Pyrolysis-GC/MS techniques, perform Evolved Gas Analysis (described in page 46) followed by a single shot/flash pyrolysis to confirm the presence of the PLA or its monomer and the general absence of other additives.

**Experimental:** Evolved Gas Analysis (EGA) was performed to identify the thermal composition of a 3D printed PLA sample. To perform EGA, around 100  $\mu\text{g}$  was cut from a 3D printed dogbone shape specimen and placed into the inert Eco-Cup. The micro-furnace was then programmed from 100 to 700°C (20°C/min). The GC oven was kept isothermal at 320°C. Compounds “evolved” continuously from the sample as the temperature increases. The obtained EGA-MS was summarized from 10 min to 15 min (300-400 °C), and the reference was directly suggested by the F-Search EGA-MS library.

**Results:** The EGA thermogram indicated that the PLA starts to degrade at 300°C and will be totally degraded at 400°C. Library search is done by F-search (interpretation library described in page 44) , which fits well with the EGA-MS of sample, giving a result that the 3D printed dogbone is consist of PLA.

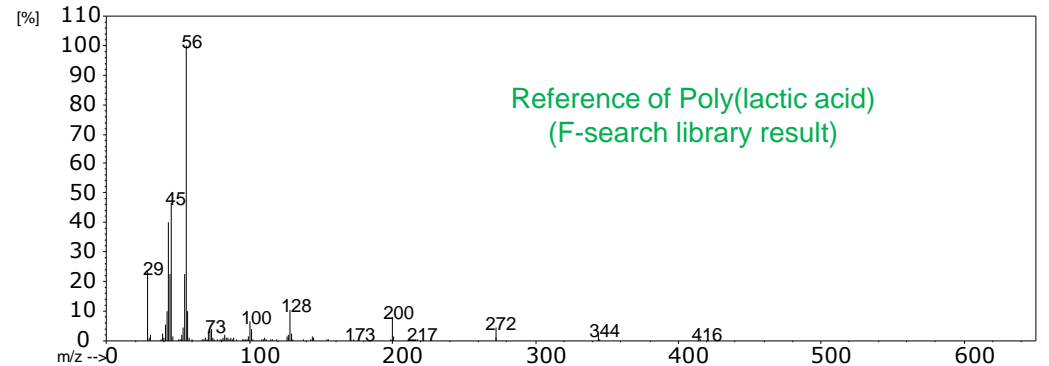
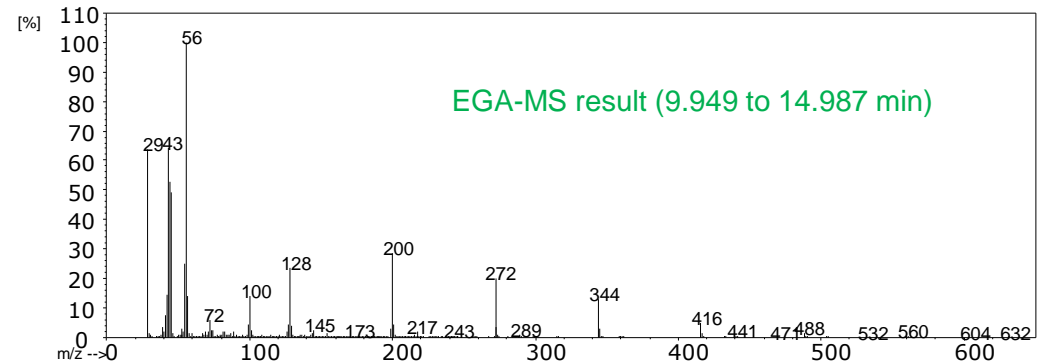
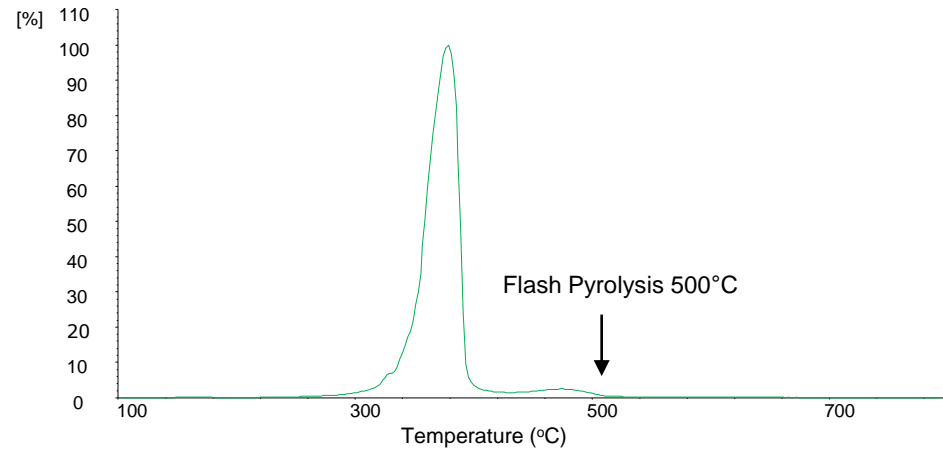

Flash pyrolysis was then performed at 500°C. By extracting the chromatogram of typical ion of compounds, they are obviously observed out of all peaks. For additives which has minor fraction in the material, they can be detected by scaling up the sample to 10 times and refocus the peak in Thermal Desorption (TD) or Heart-cut (HC).

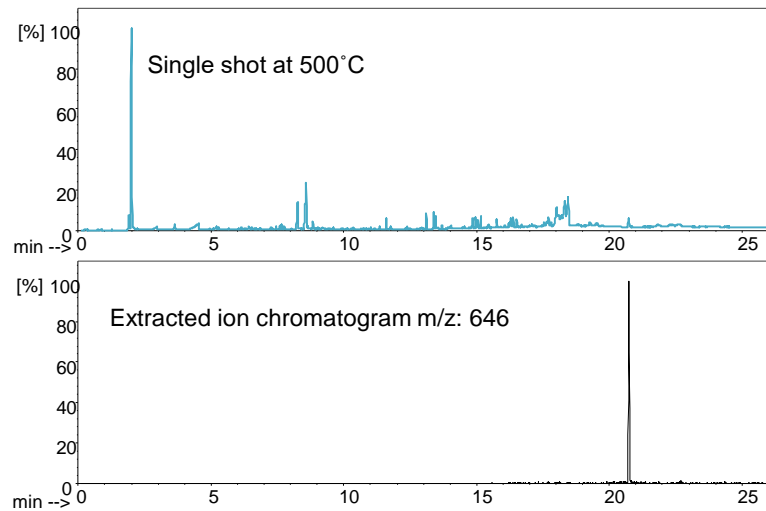

10 times more sample

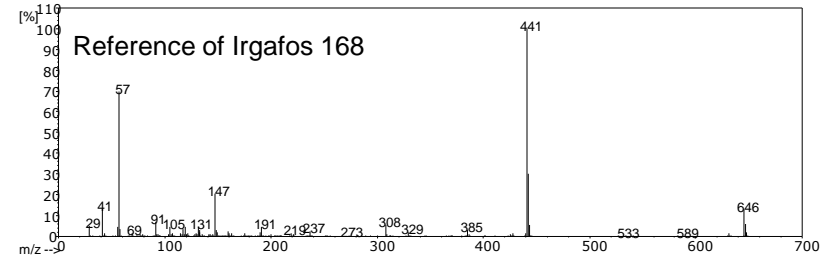
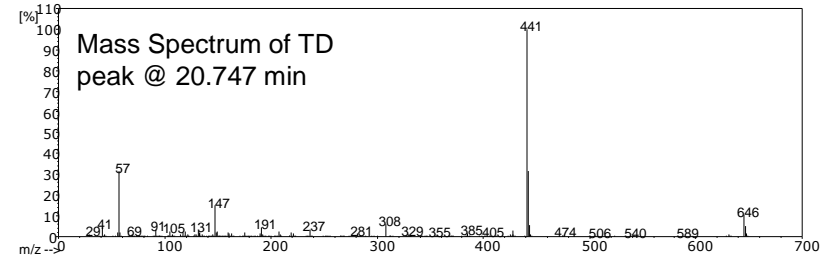
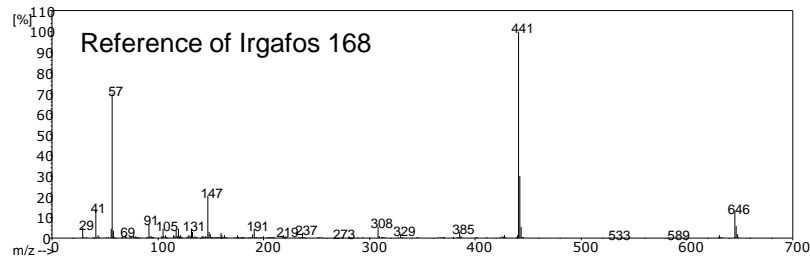
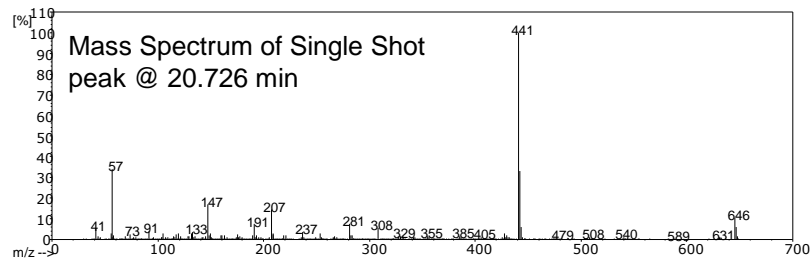
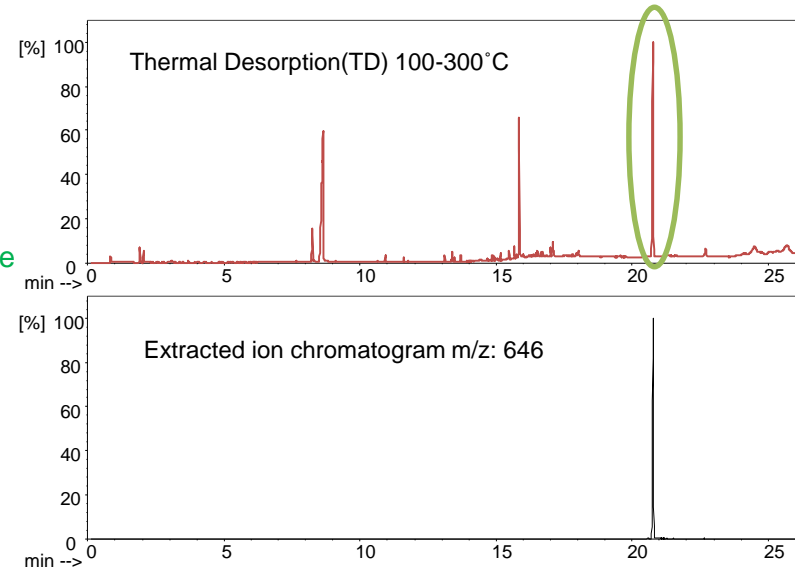



For the Thermal Desorption (TD) analysis, the heating occurs below 300°C, thus the majority peaks are ascribed to small molecules in their original form without chemical decomposition.

Monomers, additives and solvent residue are always shown in this part.

Here, the Palmitic acid monoglyceride is isolated by TD-GC/MS and its mass spectrum is highly consistent with the reference.

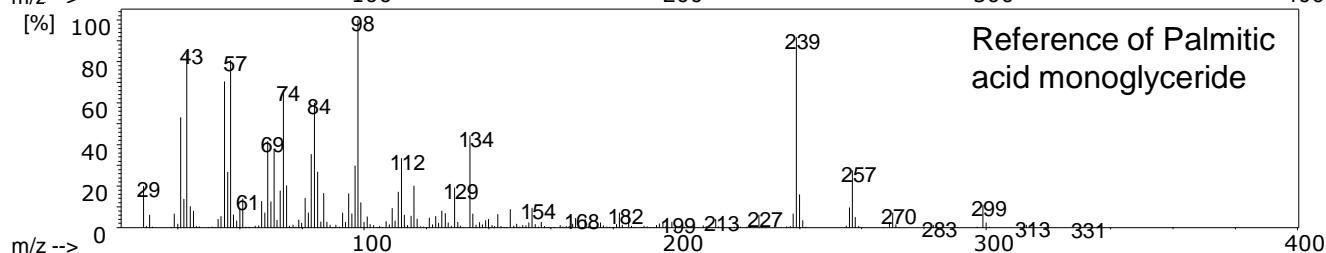
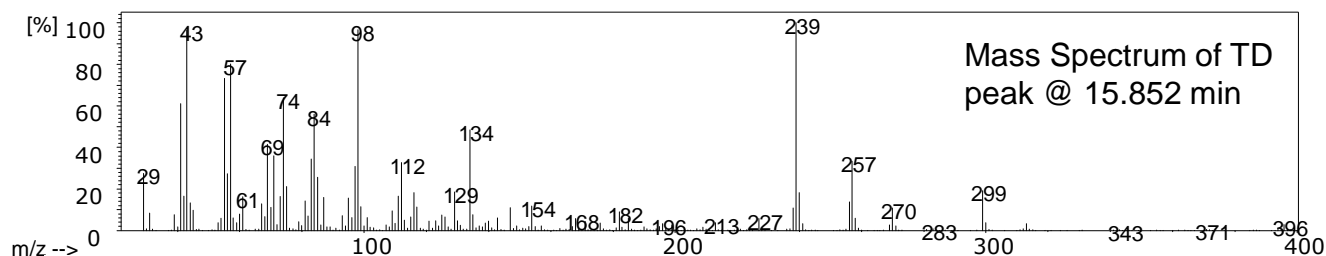
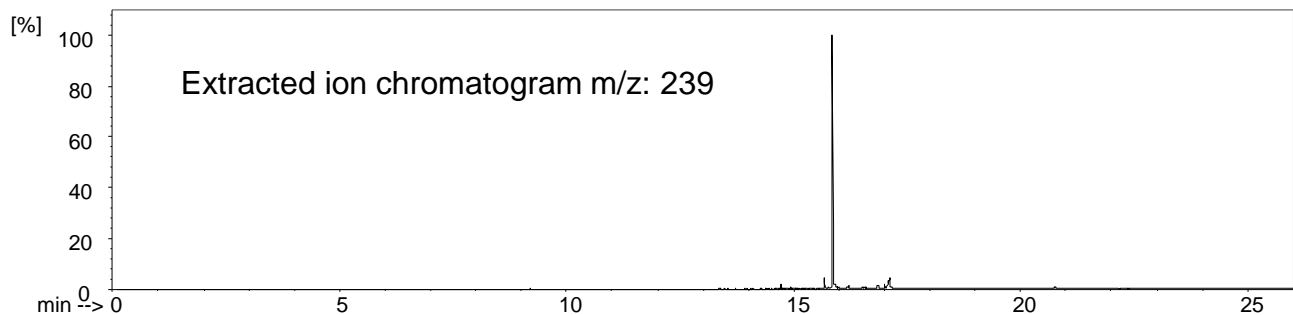
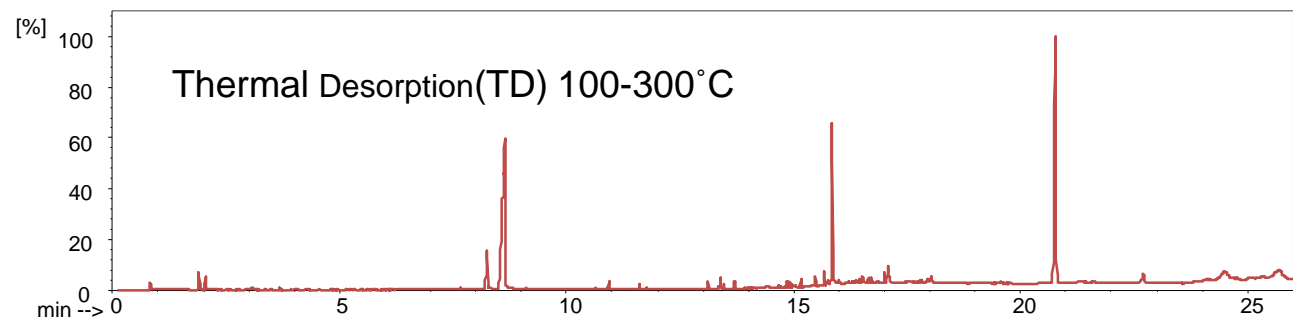

# Epoxy Adhesives and Resins as Thermosets

**Background:** Epoxy resins are a class of reactive prepolymers and polymers which contain epoxide (oxirane) groups. Reaction is based on either catalytic homopolymerization, or with a wide range of co-reactants including polyfunctional amines, acids (and acid anhydrides), phenols, alcohols and thiols (usually called mercaptans)- Part A & B. These co-reactants are often referred to as hardeners or curatives (Part B), and the cross-linking reaction is commonly referred to as curing. This results in a thermosetting polymer, often with favorable mechanical properties and high thermal and chemical resistance. Epoxy has a wide range of applications, including metal coatings, use in electronics/electrical components/LEDs, high tension electrical insulators, paint brush manufacturing, fiber-reinforced plastic materials (composites) and structural adhesives.

**Problem:** Although Epoxy is a commonly used resin and adhesive material, their commercial compositions vary enormously, and the determination of the reactive equivalent is of then the only quantifiable reaction parameter. Moreover, their use as a 3D printing material is only currently being studied. To study the composition and additives of a 3D printed objective, normal method could be destructive and requires a larger sample and preparation methods.

**Solution:** Using Pyrolysis-GC/MS techniques, perform EGA to determine the thermal profile of the sample. Then using the Hear-Cut mode of operation, perform deformation analysis to identify the additive and the pyrolysis mechanism with minimum damage to the 3D printed objective.





**Experimental:** Evolved Gas Analysis (EGA) was performed to obtain a clear picture of the thermal profile of the 3D printed object. To perform EGA, around 100  $\mu\text{g}$  was cut from a 3D printed epoxy object and then placed in an inert Eco-Cup. The micro-furnace was then programmed from 100 to 800°C (20°C/min). The GC oven was kept isothermal at 320°C. After the EGA results, the Hear-Cut technique were performed to thermally slice the sample in three zones. Zone A: 100 °C-260 °C; zone B: 300 °C to 420 °C; and zone C: 420-550 °C. About 300  $\mu\text{g}$  was cut from the 3D printed object and placed in the Eco-Cup. Gas evolved in each zone was refocused by cryo-trap. The oven temperature is programed to equilibrium at 40 °C for 2 min, increase to 320 °C by 20 °C/min and hold 320 °C for 10 minutes.

**Results:** The EGA is directly performed on a cut of cured Epoxy 3D printed objective, without any preparation step. EGA chromatogram exhibit the clear three zone of epoxy. By utilizing Hear-Cut technique, these three zone can be focused separately. This technique provide detailed information on the composition of epoxy, additives and the pyrolyzing mechanism of epoxy.

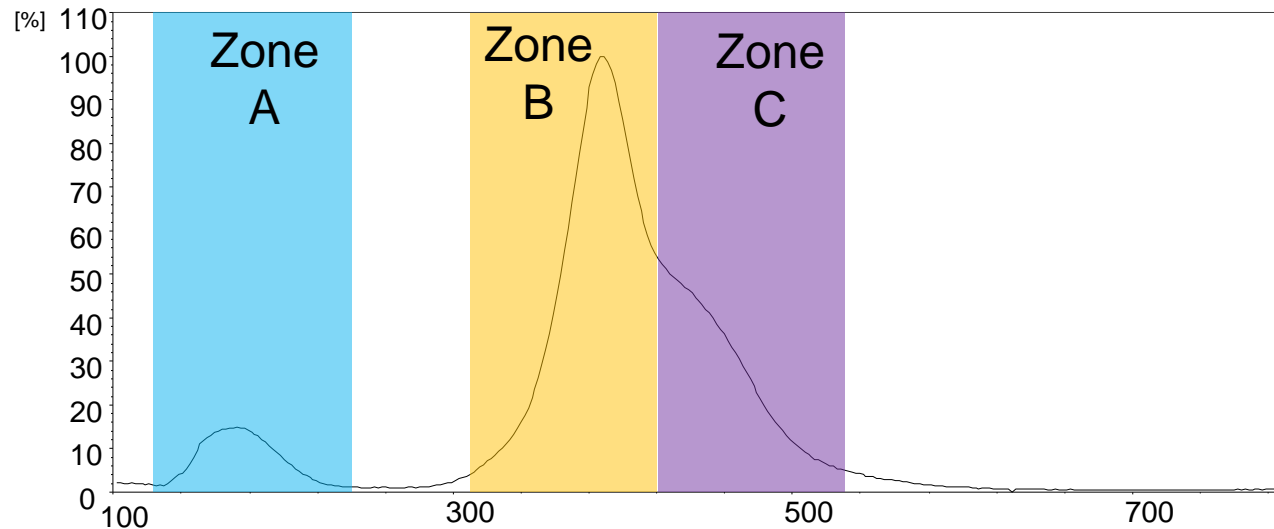

Zone A implied the presence of dibutyl phthalate as a plasticizer.

A major peak of bisphenol A and minor peak of phenol is detected in zone B, which suggest the breaking of C-O is dominated in this temperature zone and also supported that the epoxy resin is bisphenol A epoxy.

In zone C, C-C breaking is more likely to happen. Phenol, p-cresol and p-isopropylphenol were detected as major peak while bisphenol A is minor peak. Alkyl segment is detected, which may come from the hardener.

The result suggests that the Py-GC/MS is a strong technique to study the additive and its influence on pyrolysis mechanism of thermosets like epoxy.

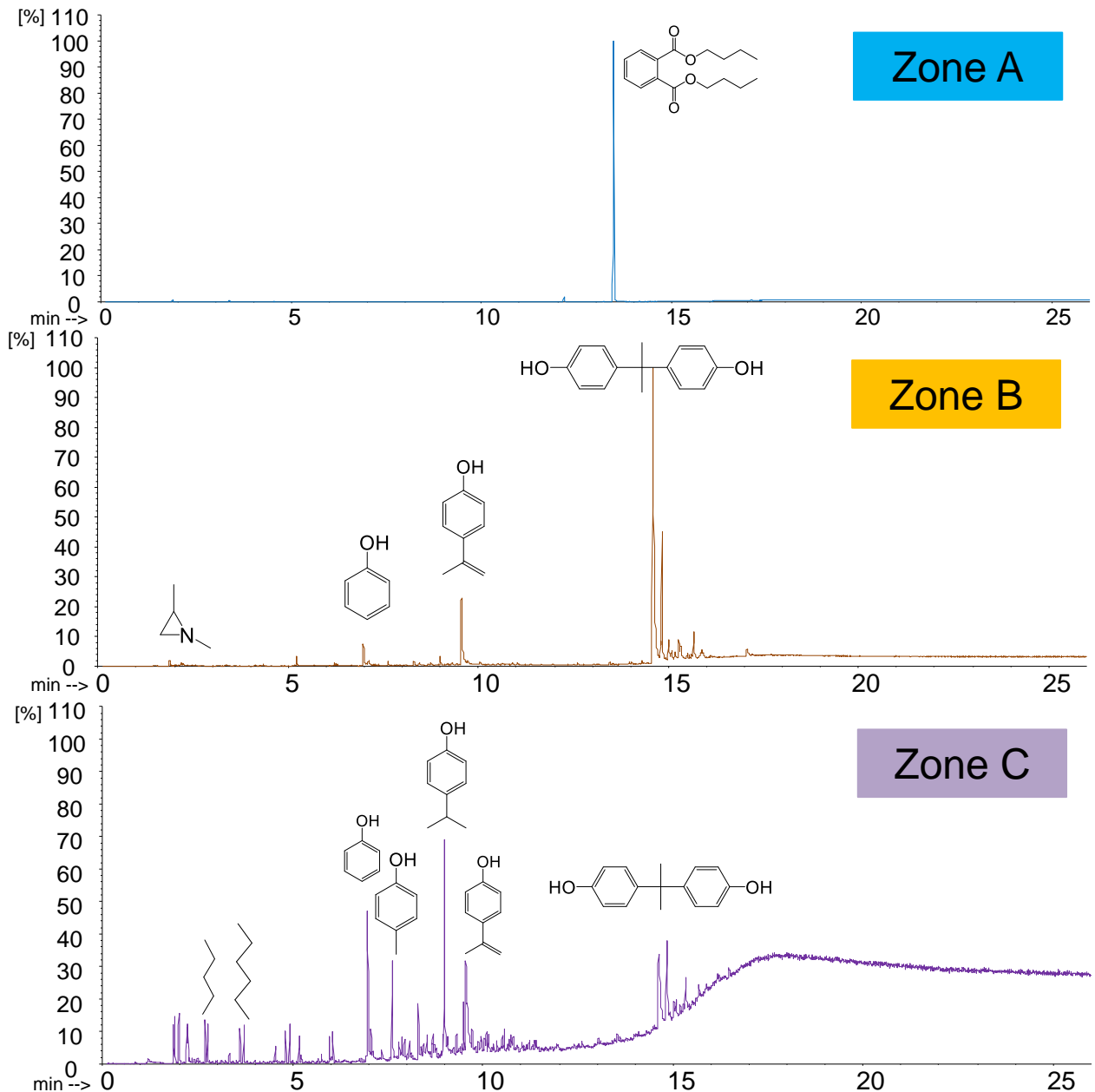

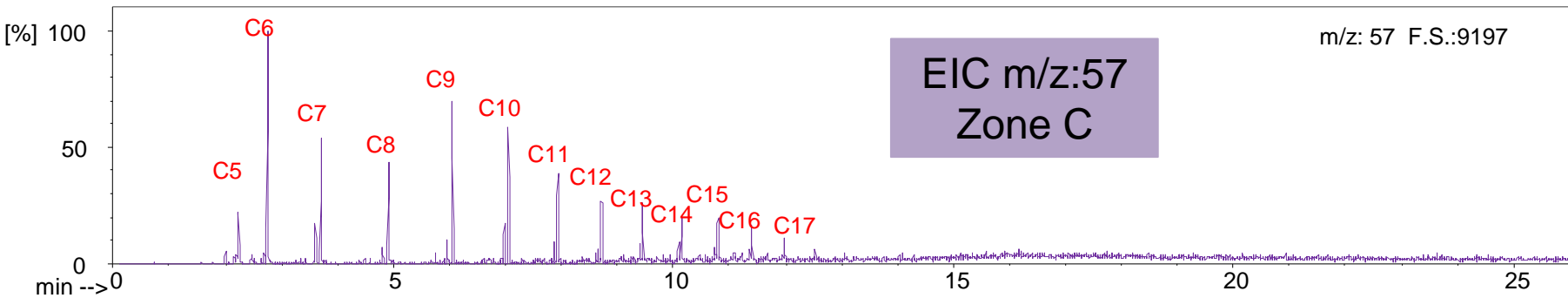
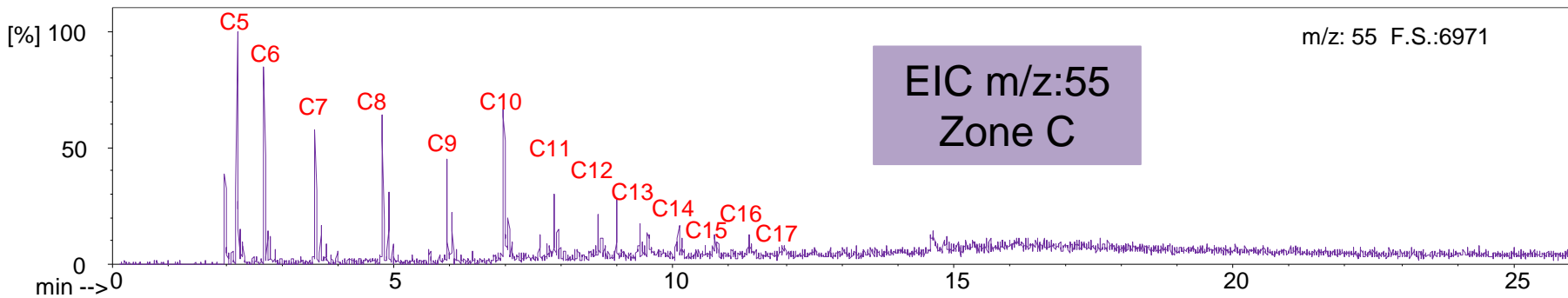
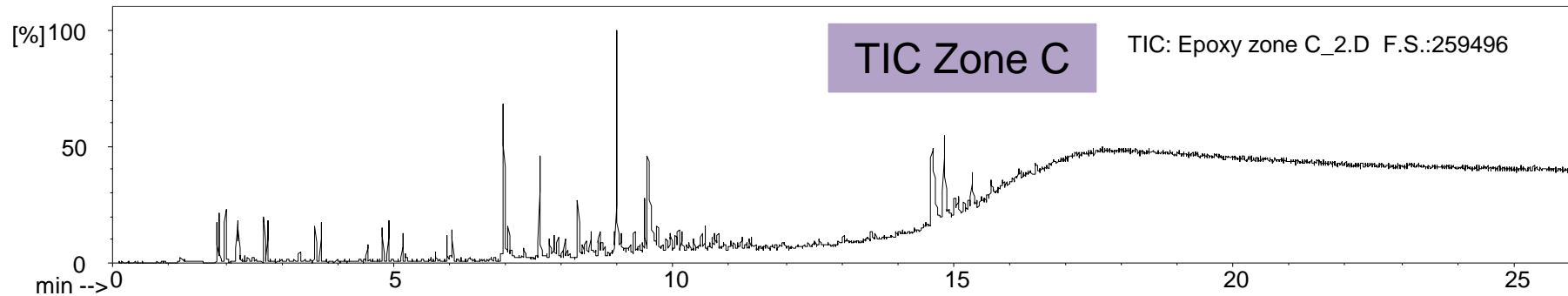

In Zone C, the carbon chain fragments are separated by the number of carbon and the shortest chain comes out first. From C5 to C17, all chains can be picked out by ion chromatogram extraction and distinguished by their mass spectrum.

# Polysiloxane - PDMS Adhesive and Resin Compositions: Thermoset Elastomers

**Background:** Polydimethylsiloxane (PDMS), also known as dimethylpolysiloxane or dimethicone, belongs to a group of polymeric organosilicon compounds that are commonly referred to as silicones. PDMS is the most widely used silicon-based organic polymer and is particularly known for its unusual rheological (or flow) properties. PDMS is optically clear, and, in general, inert, non-toxic, and non-flammable. It is one of several types of silicone oil (polymerized siloxane). Its applications range from contact lenses and medical devices to elastomers; it is also present in shampoos (as dimethicone makes hair shiny and slippery), food (antifoaming agent), caulking, lubricants and heat-resistant tiles. As an adhesive, it is one of the most common formulated materials. When cured as a rubber or adhesive, it is classified as a thermoset elastomer. There is a high interest on using silicones and formulated adhesives for 3D Printing.

**Problem:** Although silicones is a commonly used resin and adhesive material, their properties and formulation chemistry vary with different formulators and manufacturers. While IR spectroscopy can be used for screening, it is not sufficient for composition determination or distinguishing the presence of PDMS resins or sources. The materials used was a commercially available resin that is used for DIY adhesives and was subsequently used for 3D Printing.

**Solution:** Perform EGA followed by a single shot analysis to confirm the presence of the PDMS or its other polymer contents and the general presence of other additives.

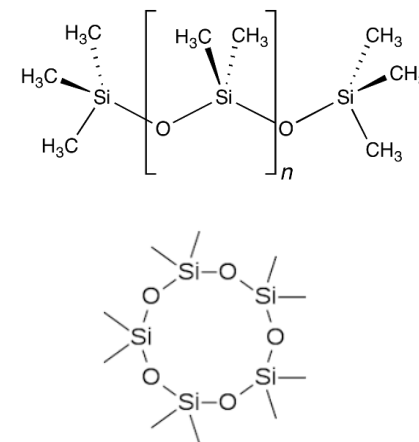

**Experimental:** Evolved Gas Analysis (EGA) was performed first from 100 to 700°C (20°C/min). The GC oven was kept isothermal at 320°C. A single shot GC/MS analysis was then performed. As shown in the figure, using the F-Search EGA-MS library, the intense peaks in all the EGA thermograms were identified as PDMS compositions.

**Results:** The EGA chromatogram demonstrated the 3D printed porous PDMS starts to degrade at 460°C and will be totally degraded at 660°C. The EGA-MS was created by summarize the spectra from 460°C to 660°C. Library search is done by F-search, which fits well with the EGA-MS of sample.

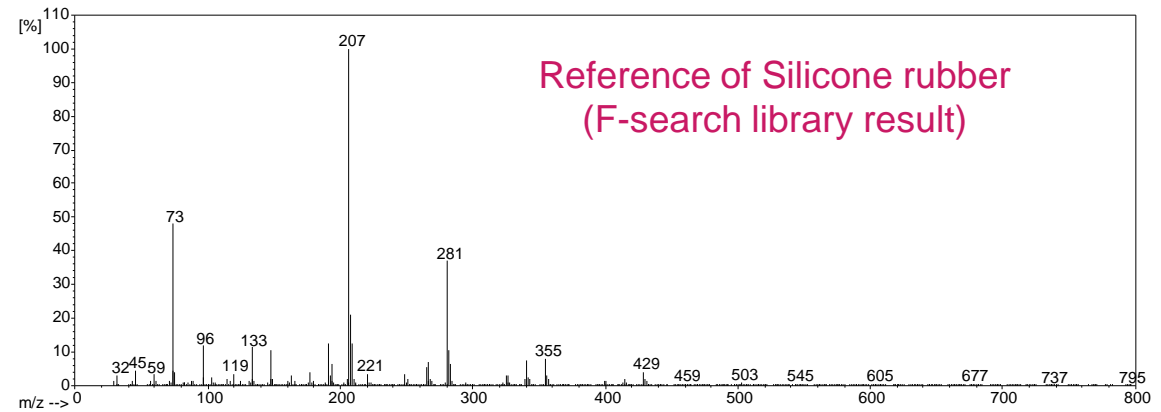
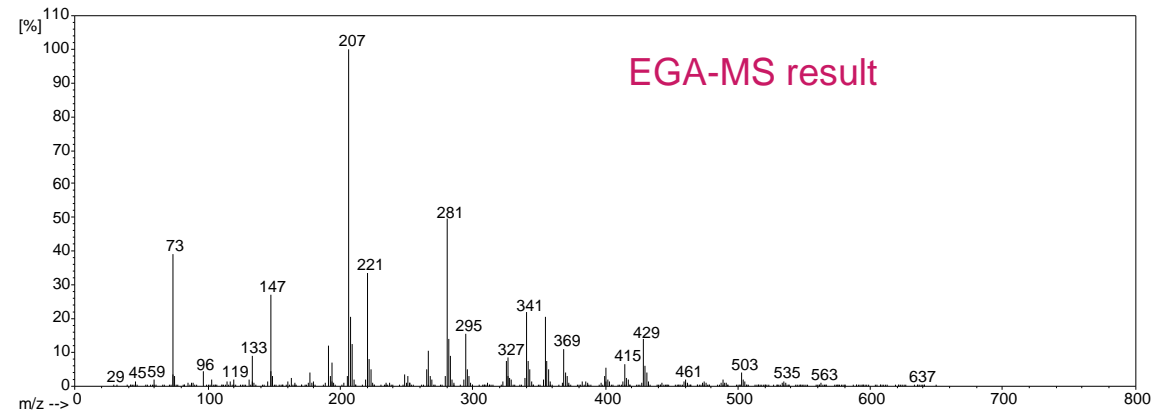
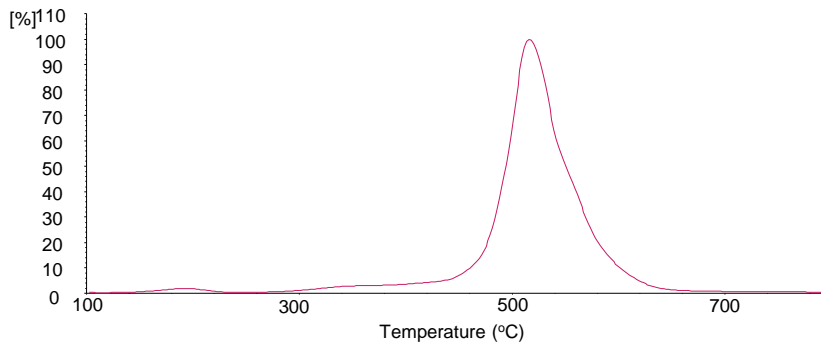

Single shot result was analyzed by using F-search compound library. A major peak of D3 is detected, demonstrating the small slicing of PDMS chain. Other minor peak stands for the higher order of D4, D5, D6, D7 and D8, standing for the larger fragment of PDMS chains. This results prove the presence of PDMS in the 3D printed porous object.

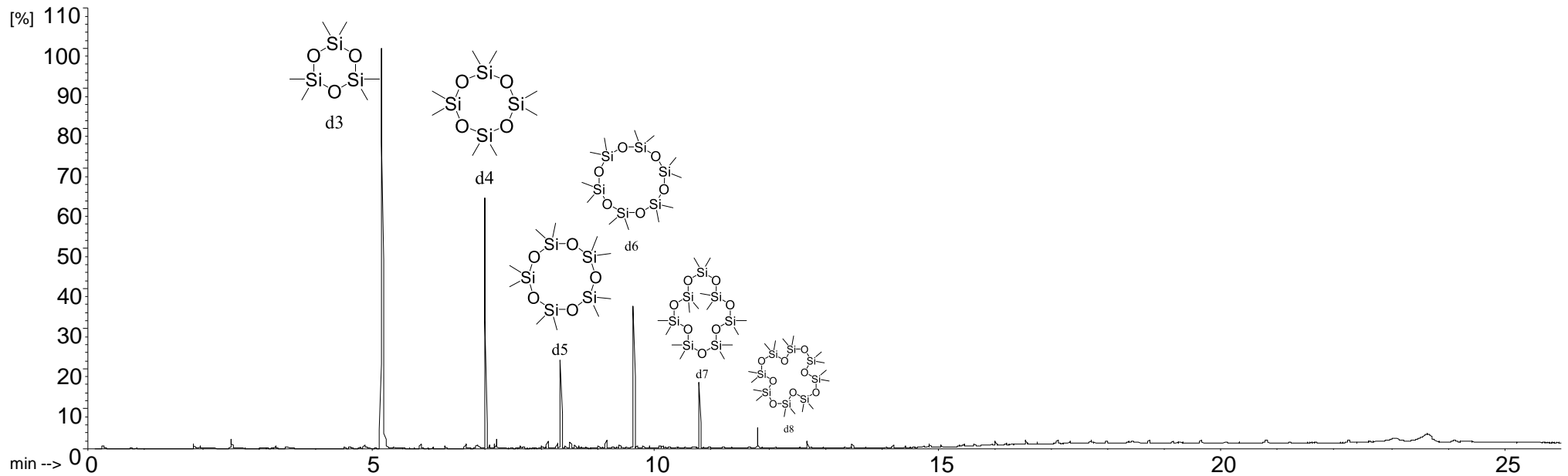



Thermal desorption of ten times more samples dramatically exaggerate the presence of additives. After locating the ion size at  $m/z$  149 and search in the compound library, this additive is proved to be dibutyl phthalate (DBP).

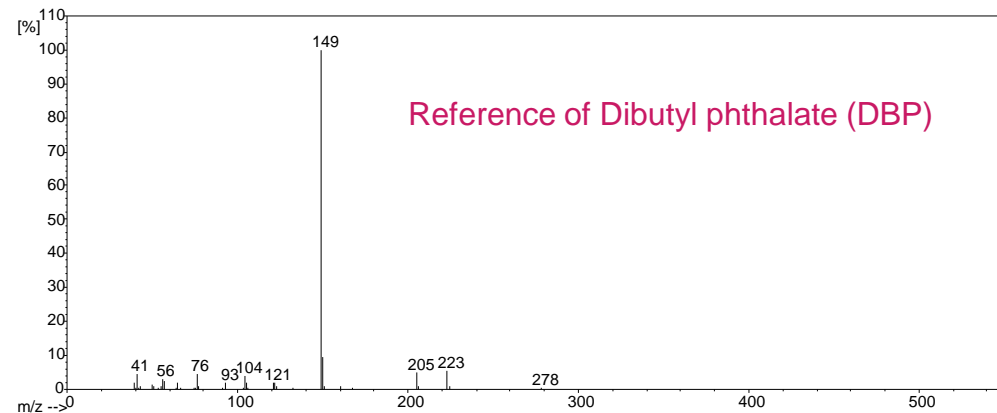
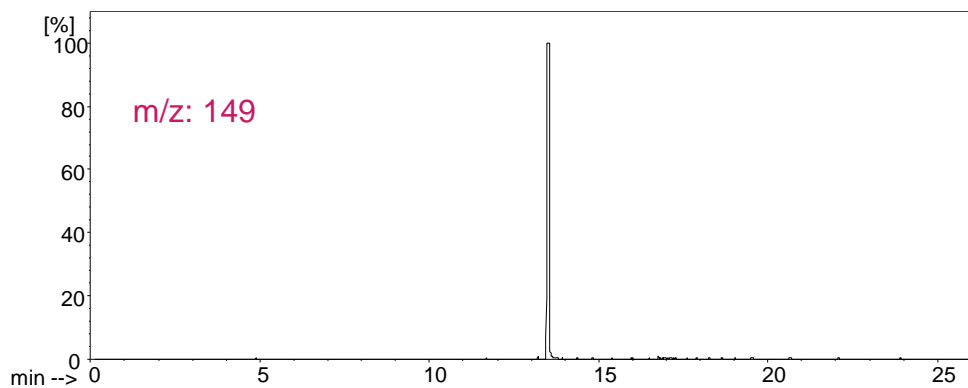
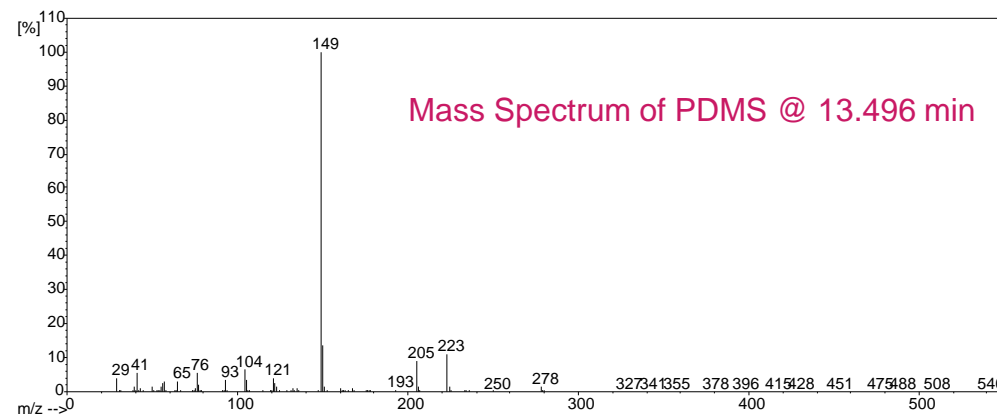
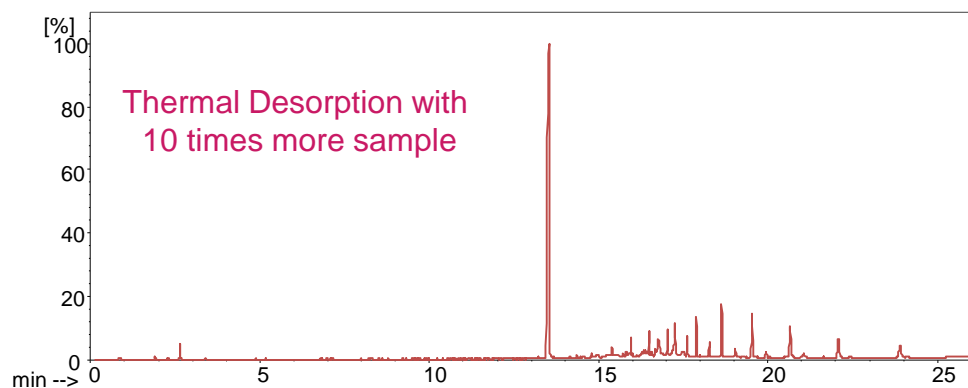

# Polyphenylene Ether (PPE) Resins and Filaments

**Background:** Poly(p-phenylene oxide)(PPO) or poly(p-phenylene ether) (PPE) is a high-temperature thermoplastic. It is rarely used in its pure form due to difficulties in processing. It is mainly used as a blend with polystyrene, high impact styrene-butadiene copolymer or polyamide. PPO is a registered trademark of a commercial Innovative Plastics and is commercially known as Noryl. There is a high interest in using PPO or PPE for 3D Printing. PPE blends are used for structural parts, electronics, household and automotive items that depend on high heat resistance, dimensional stability, and accuracy. They are also used in medicine for sterilizable instruments made of plastic. This plastic is processed by injection molding or extrusion; depending on the type, the processing temperature is 260-300 °C. The surface can be printed, hot-stamped, painted or metalized. Welds are possible by means of heating element, friction or ultrasonic welding. It can be glued with halogenated solvents or various adhesives.

**Problem:** Although PPE is a commonly used high performance polymer resin and 3D printing material, their properties and formulation chemistry vary with different formulators and manufacturers. While IR spectroscopy can be used for screening, it is not sufficient for composition determination or distinguishing the presence of PPO resins or sources. The materials used was a commercially available resin that is used for 3D Printing.

**Solution:** Perform EGA followed by a single shot analysis to confirm the presence of the PPE or its other polymer contents and the general presence of other additives of a commercial filament.

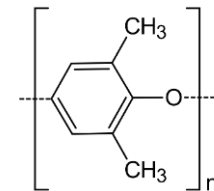

**Experimental:** Around 100µg of an extruded filament from commercial pellet was cut into an inert Eco-Cup and placed in the auto sampler. To perform EGA, the micro-furnace was then programmed from 100 to 800°C (20°C/min). The GC oven was kept isothermal at 320°C.

A single shot analysis was done at 600 °C, determined from EGA thermogram. The oven temperature is programmed to equilibrium at 40 °C for 2 min, increase to 320°C by 20 °C/min and hold 320 °C for 10 minutes. The result was analyzed by F-search library of component.

**Results:** The EGA chromatogram demonstrated the PPE filament starts to degrade at 440°C and will be totally degraded at 600°C.

The EGA-MS was created by summarize the spectra from 440°C to 600°C. Library search is done by F-search, which fits well with the EGA-MS of sample.

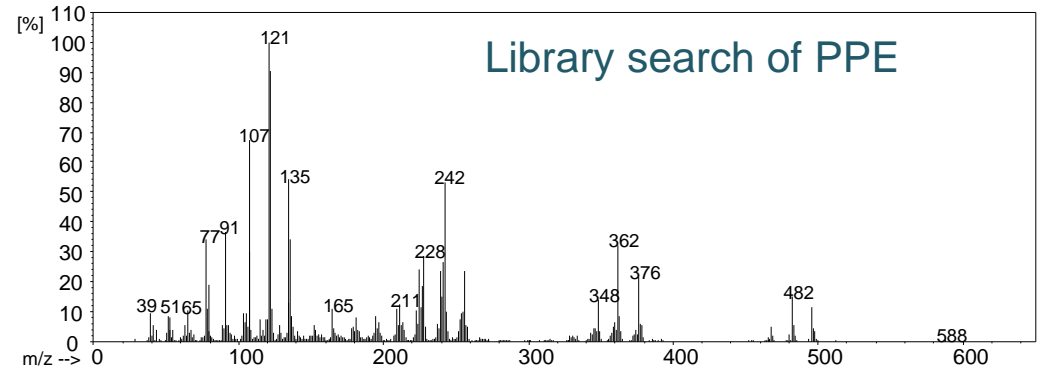
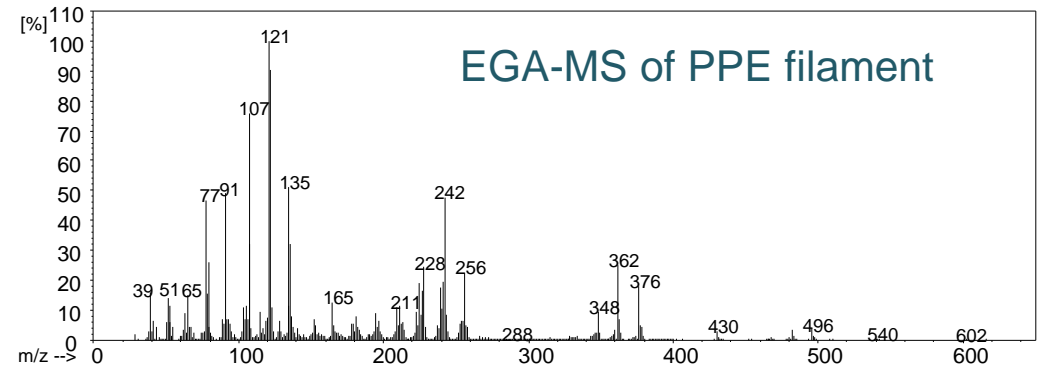
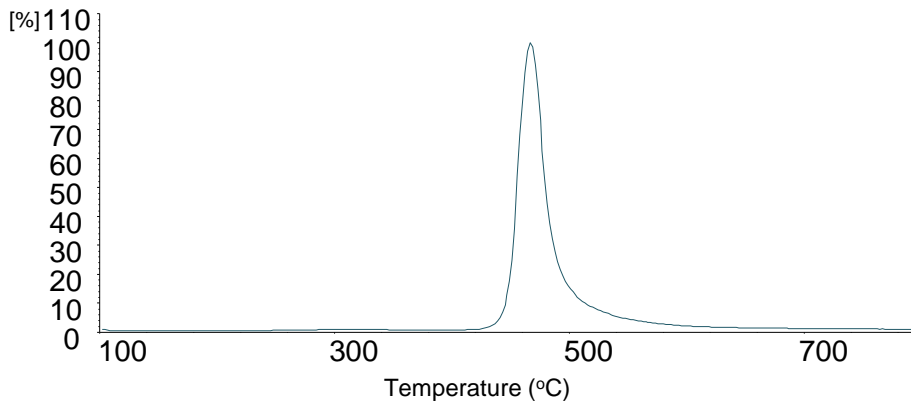

By utilizing pyrolysis at 600°C, the fragments of PPE filament can be studied. o-Cresol, dimethylphenol and trimethylphenol were detected which suggested the presence of monomer. Dimers were also detected from 10 min to 15 min, while trimers were observed at 17 min. These results proved the presence of PPE polymer.

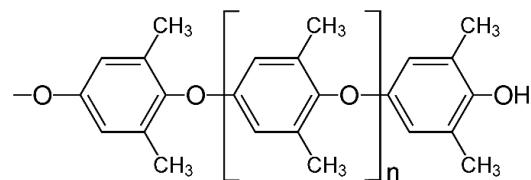
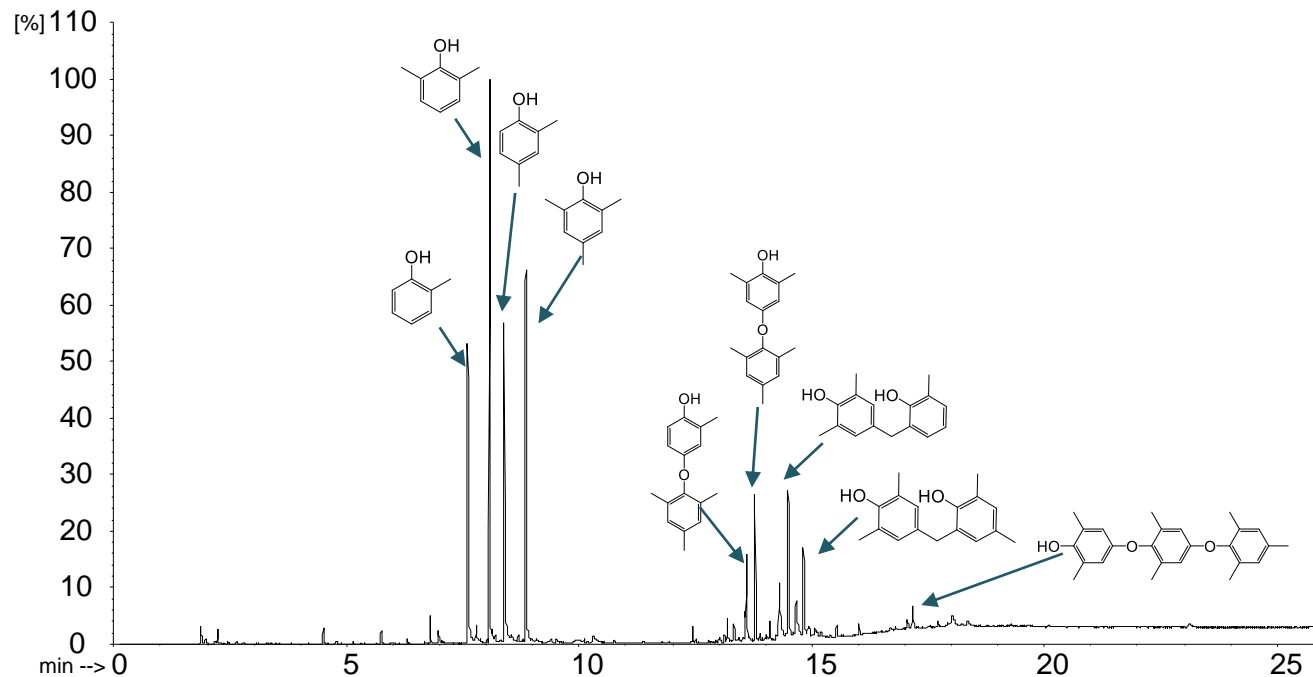

Polyphenylene ether(PPE)

Thermal Desorption (TD) mode of operation was also used to confirm the presence of two additives. TD was performed from 100-380°C. The Total Ion Chromatogram (TIC) is shown on the right-hand side. The Extracted Ion Chromatograms (EICs) of  $m/z:84$  and  $m/z:149$  indicates N-Butylidenebutylamine and Dibutyle Phthalate (DBP), respectively.

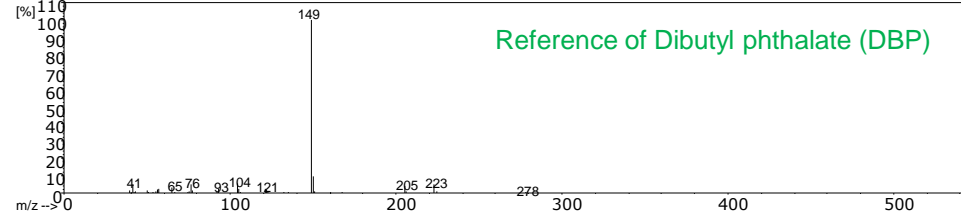
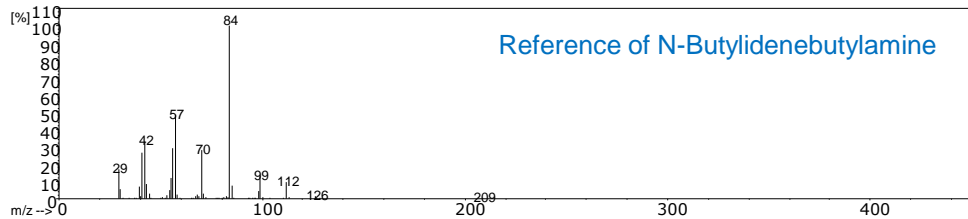
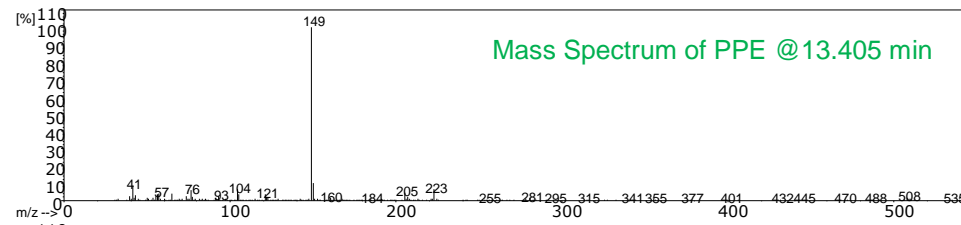
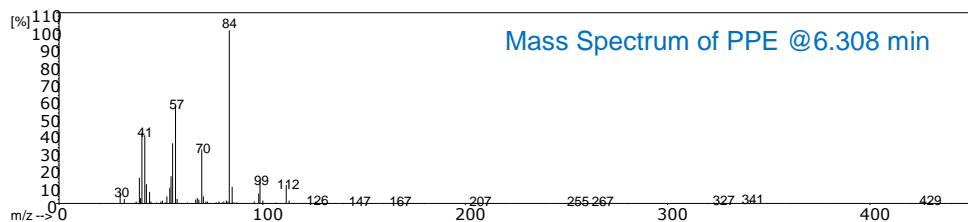
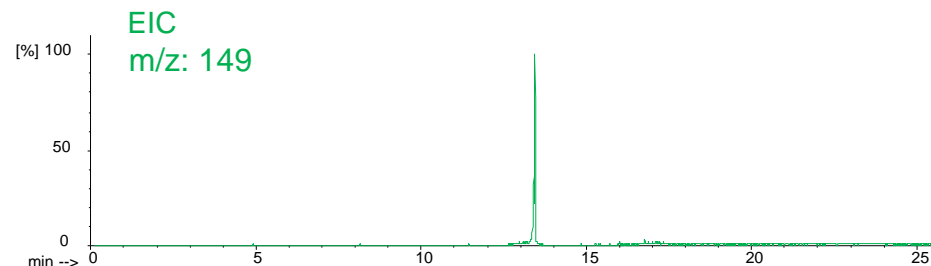
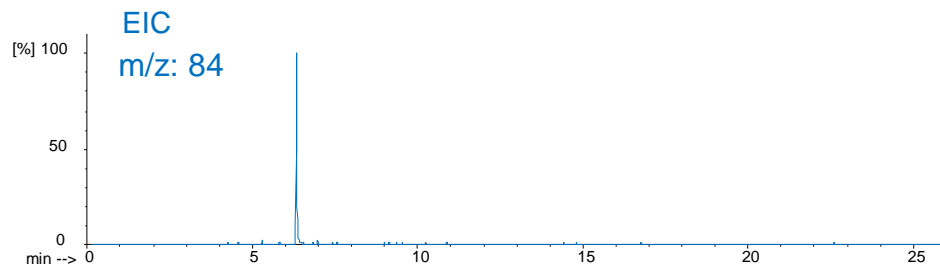
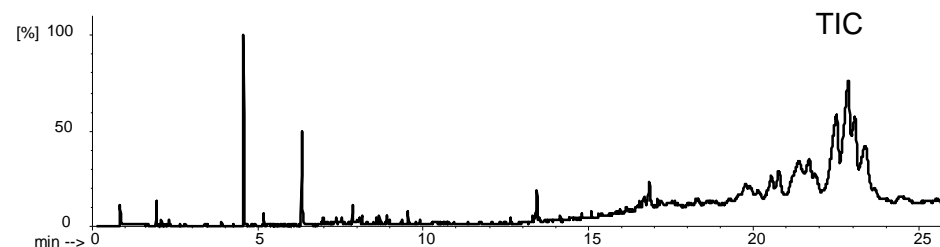

# Polyphenylene Sulfide (PPS) Resins and Filament

**Background:** Polyphenylene sulfide (PPS) is a high-performance polymer consisting of aromatic rings linked by sulfides. Synthetic fiber and textiles derived from this polymer resist chemical and thermal attack. PPS is used in filter fabric for coal boilers, papermaking felts, electrical insulation, film capacitors, specialty membranes, gaskets, and packings. PPS is the precursor to a conductive polymer of the semi-flexible rod polymer family. The PPS, which is otherwise insulating, can be converted to the semiconducting form by oxidation or use of dopants. PPS as a high-performance polymer can be molded, extruded, or machined to tight tolerances. In its pure solid form, it may be opaque white to light tan in color. Maximum service temperature is 218 °C (424 °F). PPS has not been found to dissolve in any solvent at temperatures below approximately 200 °C (392 °F). There is high interest in using these materials for additive manufacturing.

**Problem:** Although PPS is a commonly used high performance polymer resin and 3D printing material, their formulation chemistry vary with different formulators and manufacturers. While IR spectroscopy and be used for screening, it is not sufficient for composition determination. Solid state NMR can provide detailed information of composition, while it's sophisticated to operate and interpret.

**Solution:** Pyrolysis-GC/MS provides a simple and rapid determination of composition analysis of an extruded PPS filament. EGA followed by a single shot analysis are performed to confirm the presence of the PPS.

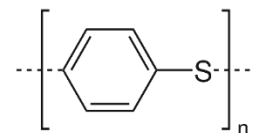



**Experimental:** 100 µg sample was cut from an extruded PPS filament and placed into the inert Eco-Cup sample. The micro-furnace was then programmed from 100 to 800°C (20°C/min) to perform EGA. The GC oven was kept isothermal at 320°C. Flash pyrolysis technique was done by using single shot mode at a 700°C. The oven temperature is programmed to equilibrium at 40 °C for 2 min, increase to 320°C by 20 °C/min and hold 320 °C for 10 minutes.



**Results:** The EGA thermogram indicates that PPS started to degrade at 480°C and completely at 700°C. Therefore, flash pyrolysis was performed at 700°C.

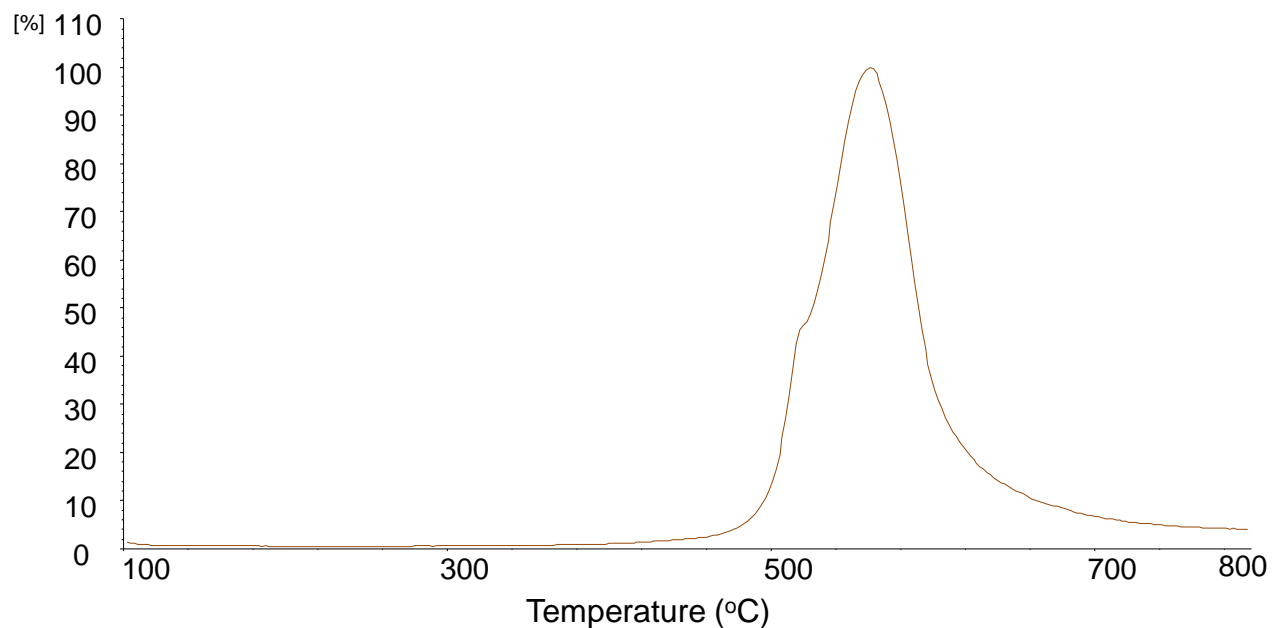

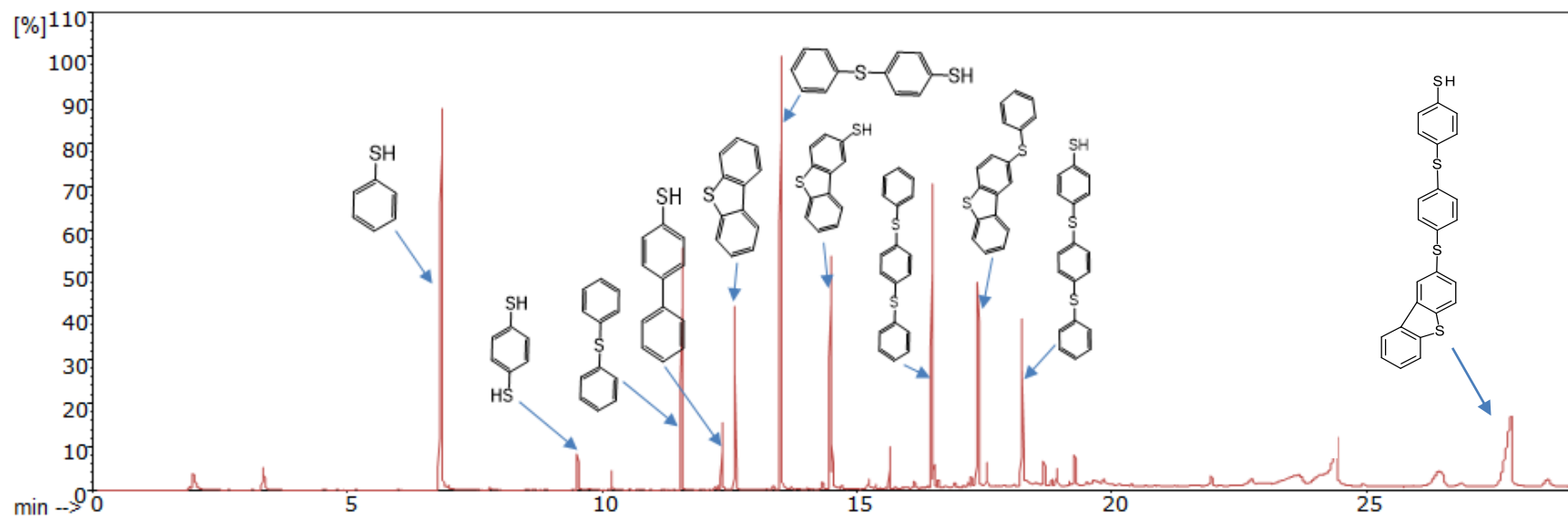

In the single shot mode, PPS was flash pyrolyzed at 700 °C, all the obtained peaks were assigned by using F-search libraries. Monomer PPS (Benzenethiol), PPS dimer(3-phenylthiolbenzenethiol) were detected as major peak.

Dithiolbenzene, diphenylsulfide, phenylbenzenethiol, dibenzothiophene, 3-thiol dibenzothiophene, 1,3-bisphenylthiobenzene, 2-(phenylthio)dibenzothiophene and 3-((3 (phenylthio)phenyl)thio)benzenethiol were detected as the minor peak. These result demonstrated the complete presence of PPS.

# ULTEM or Polyetherimide (PEI) Resins and Filament

**Background:** Polyetherimide (PEI) is an amorphous, amber-to-transparent thermoplastic with characteristics similar to the related plastic PEEK. Ultem is a family of PEI products manufactured by a commercial supplier. Ultem resins are used in medical and chemical instrumentation due to their heat resistance, solvent resistance and flame resistance. Ultem 1000 (standard, unfilled polyetherimide) has a high dielectric strength, inherent flame resistance, and extremely low smoke generation. Ultem has high mechanical properties and performs in continuous use to 340 °F (170 °C) and is easily machined and fabricated with excellent strength and rigidity. The glass transition temperature of PEI is 217 °C. It is able to resist high temperatures with stable electrical properties over a wide range of frequencies. This high strength material offers excellent chemical resistance and ductile properties suitable for various applications, even for 3D Printed objects and parts.

**Problem:** Although PEI is a commonly used high performance polymer resin and 3D printing material, their properties and formulation chemistry vary with different formulators and manufacturers. While IR spectroscopy can be used for screening, it is not sufficient for composition determination or distinguishing the presence of PEI resins or sources. The material used was a commercially available resin that is used for 3D Printing.

**Solution:** Perform EGA followed by a single shot analysis to confirm the presence of the PEI or its other polymer contents and the general presence of other additives.



**Experimental:** About 100 µg of sample was cut from an extruded filament, placed in the inert Eco-Cup and into the auto sampler. To perform EGA, the micro-furnace was then programmed from 100 to 800°C (20°C/min). The GC oven was kept isothermal at 320°C. Flash pyrolysis technique was done by using single shot mode at a 700°C (this optimal temperature was obtained from the EGA thermogram). The oven temperature is programmed to equilibrium at 40 °C for 2 min, increase to 320°C by 20 °C/min and hold 320 °C for 10 minutes.

**Results:** EGA provided a clear picture of the thermal profile of the Ultem filament sample. According to the result, Ultem started to degrade at 500°C and completed at 660°C. Therefore, flash pyrolysis will be performed at 700°C.

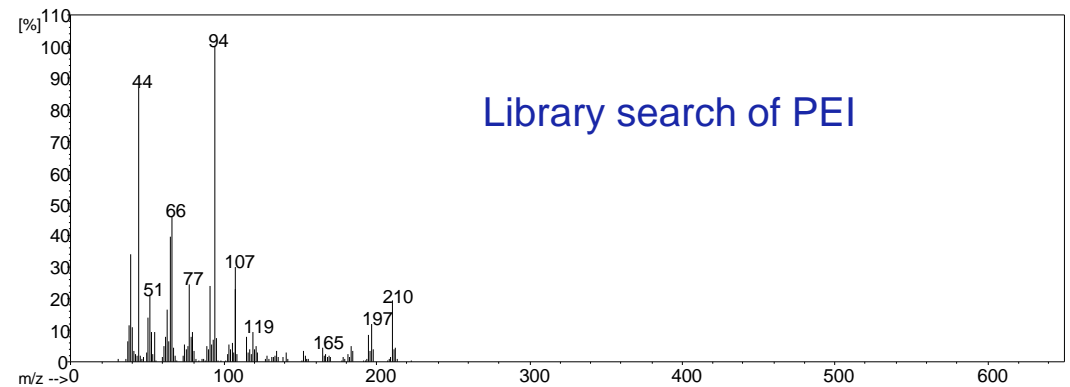
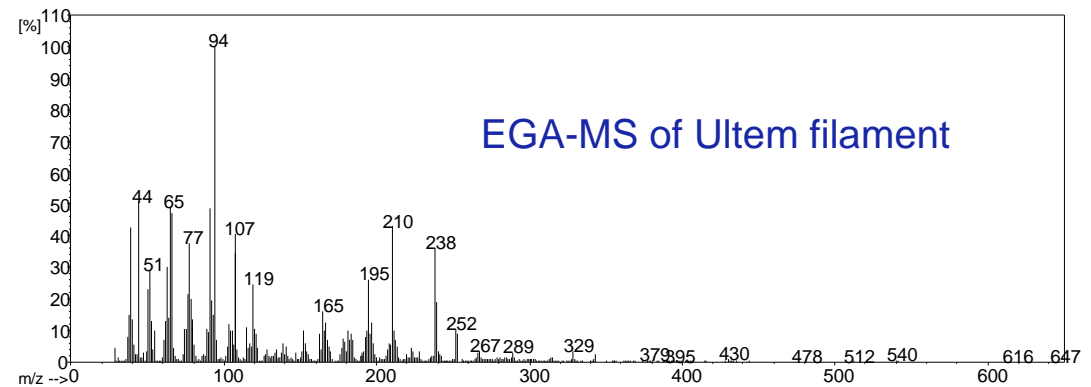
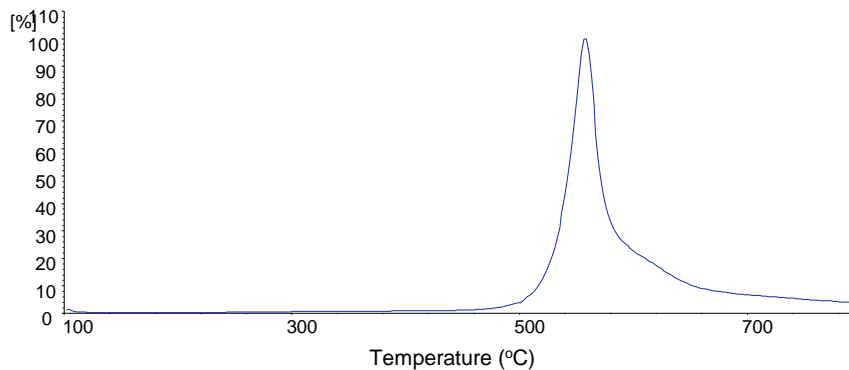

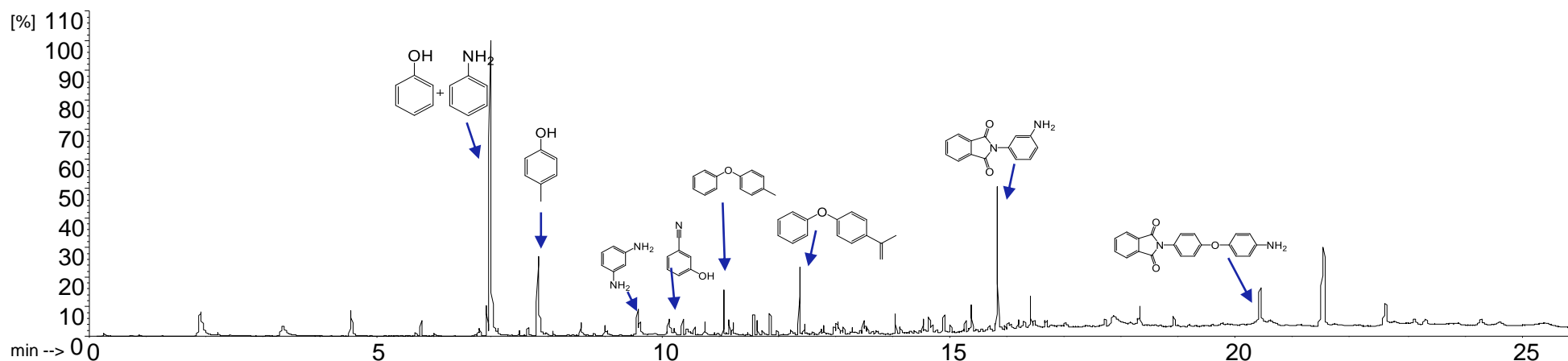
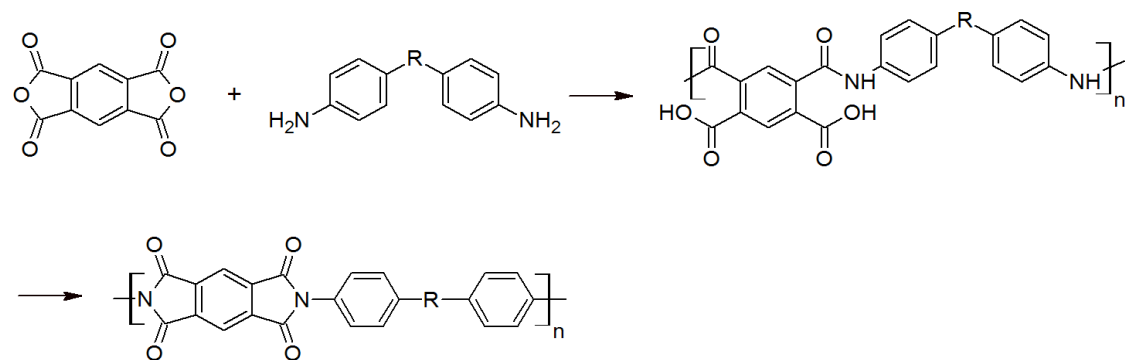

Single shot GC/MS result was analyzed by using F-search library. A major peak of mixture of aniline and phenol is detected. Minor peaks stands for bisphenylether derivatives were detected, demonstrating the R group of the structure showing below is ether.

# Polyetheretherketone (PEEK) High Performance Plastics

**Background:** Polyether ether ketone (PEEK) is a colorless organic thermoplastic polymer in the polyaryletherketone (PAEK) family, used in engineering applications. PEEK polymers are obtained by step-growth polymerization by the dialkylation of bisphenolate salts. Typical is the reaction of 4,4'-difluorobenzophenone with the disodium salt of hydroquinone, which is generated in situ by deprotonation with sodium carbonate. The reaction is conducted around 300 °C in polar aprotic solvents - such as diphenyl sulfone. PEEK is a semi crystalline thermoplastic with excellent mechanical and chemical resistance properties that are retained to high temperatures. The processing conditions used to mold PEEK can influence the crystallinity and hence the mechanical properties. This high strength material offers excellent chemical resistance and ductile properties suitable for various applications, even for 3D Printed objects and parts.

**Problem:** Although PEEK is a high-performance polymer resin and is a very challenging 3D printing material, their properties and formulation chemistry vary with different formulators and manufacturers. While IR spectroscopy can be used for screening, it is not sufficient for composition determination or distinguishing the presence of PEEK resins or sources. The materials used was a commercially available resin that is used for 3D Printing.

**Solution:** Perform EGA followed by a single shot analysis to confirm the presence of the PEEK or its other polymer contents and the general presence of other additives.





**Experimental:** Two commercial filament samples for 3D printing were investigated. EGA was performed first to obtain a clear picture of the thermal profile of the unknown sample. About 100  $\mu\text{g}$  of sample was cut from a 3D printed object. The micro-furnace was then programmed from 100 to 800°C (20°C/min). The GC oven was kept isothermal at 320°C. Flash pyrolysis technique was done by using single shot mode at a 700°C. The oven temperature is programmed to equilibrium at 40 °C for 2 min, increase to 320°C by 20 °C/min and hold 320 °C for 10 minutes.

**Results:** EGA of 3D printed PEEK object was performed. According to the result, PEEK-Intamsys demonstrates a slightly higher degradation temperature than PEEK-Indmatec, which probably indicate the difference in molecular weight.

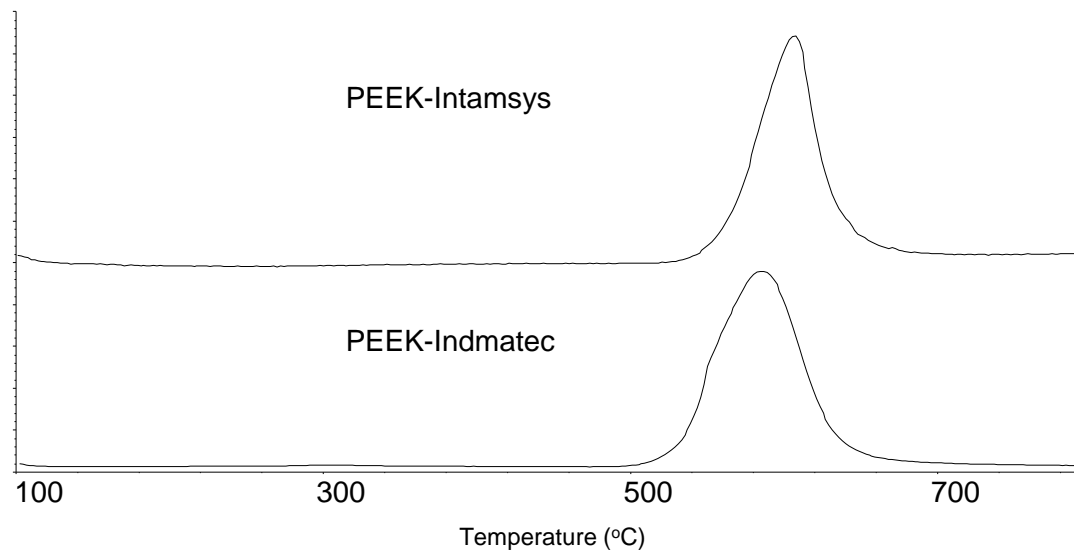

Both 3D printed samples demonstrated a major peak of phenol and minor peak of dimer phenyl ether and benzophenone, which proved the presence of PEEK.

The results demonstrated that there is no big difference in composition of the two PEEK commercial samples, the difference in degradation temperature may be related to the molecular weight.

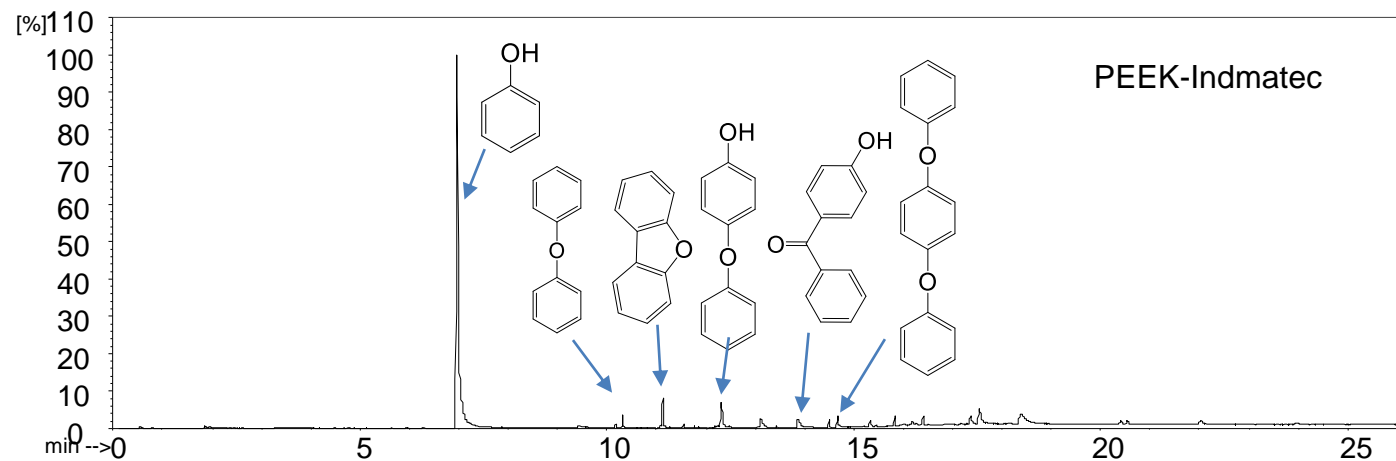
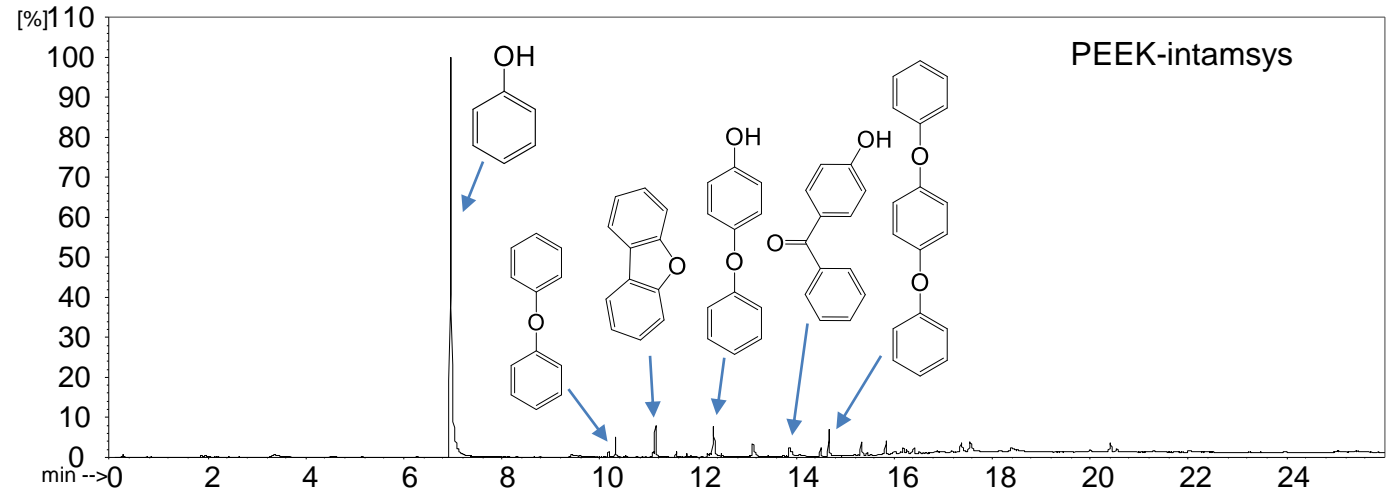
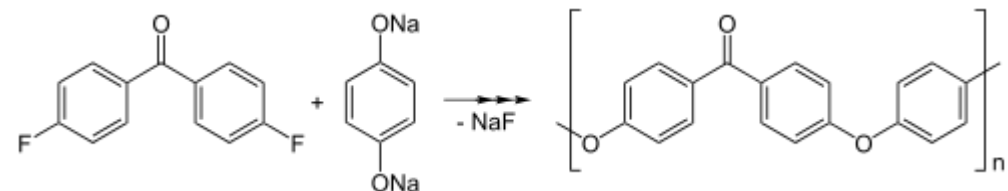
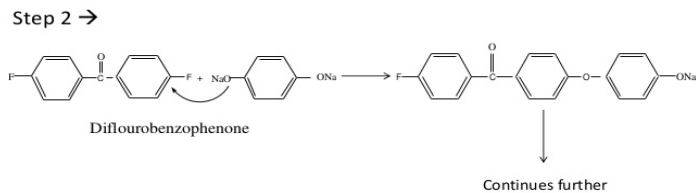
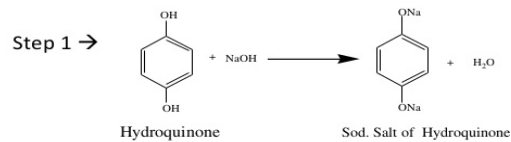

# Nylon 12 Powder Resins and for SLS 3D Printing

**Background:** Nylon 12 is a polymer with the formula  $[(\text{CH}_2)_{11}\text{C}(\text{O})\text{NH}]_n$ . It is made from  $\omega$ -aminolauric acid or laurolactam monomers that each have 12 carbons, hence the name 'Nylon 12'. It is one of several nylon polymers including the common Nylon 6 and Nylon 66. Nylon 12 can be produced through two routes. The first being polycondensation of  $\omega$ -aminolauric acid, a bifunctional monomer with one amine and one carboxylic acid group. The second route is ring-opening polymerization of laurolactam at 260-300°C. Ring-opening polymerization is the preferred route for commercial production. Nylon 12 exhibits properties between short chain aliphatic nylons. At 178-180 °C, the melting point of nylon 12 is the lowest among the important polyamides. Its mechanical properties, such as hardness, tensile strength, and resistance to abrasion, low water absorption and density, 1.01 g/mL, result from its relatively long hydrocarbon chain length, which also confers its dimensional stability. This highly desirable engineering polymer material offers excellent chemical resistance and ductile properties suitable for various applications, even for 3D printed objects and parts from powders via selective laser sintering (SLS) and filaments.

**Problem:** Although Nylon 12 is a highly desirable resin their properties and formulation chemistry vary with different formulators and manufacturers. While IR spectroscopy can be used for screening, it is not sufficient for composition determination or distinguishing the presence of Nylon 12 resins or sources. The material used was a commercially available resin that is used for 3D Printing.

**Solution:** Perform EGA followed by a single shot analysis to confirm the presence of the Nylon 12 or its other polymer contents and the general presence of other additives.

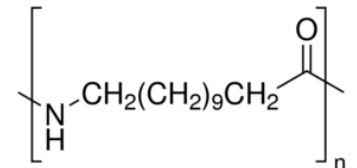

**Experimental:** About 100 µg of sample was cut from a 3D printed object to perform EGA. The micro-furnace was programmed from 100 to 800°C (20°C/min). The GC oven was kept isothermal at 320°C. Flash pyrolysis technique was done using single shot mode at a 700°C. The oven temperature is programmed to equilibrium at 40 °C for 2 min, increase to 320°C by 20 °C/min and hold 320 °C for 10 minutes.

**Results:** The EGA thermogram demonstrated Nylon 12 materials start to degrade at 300°C and will be totally degraded at 540°C. Library search is done by F-search, which fits well with the EGA-MS of sample, giving a result that the 3D printed object is Nylon 12

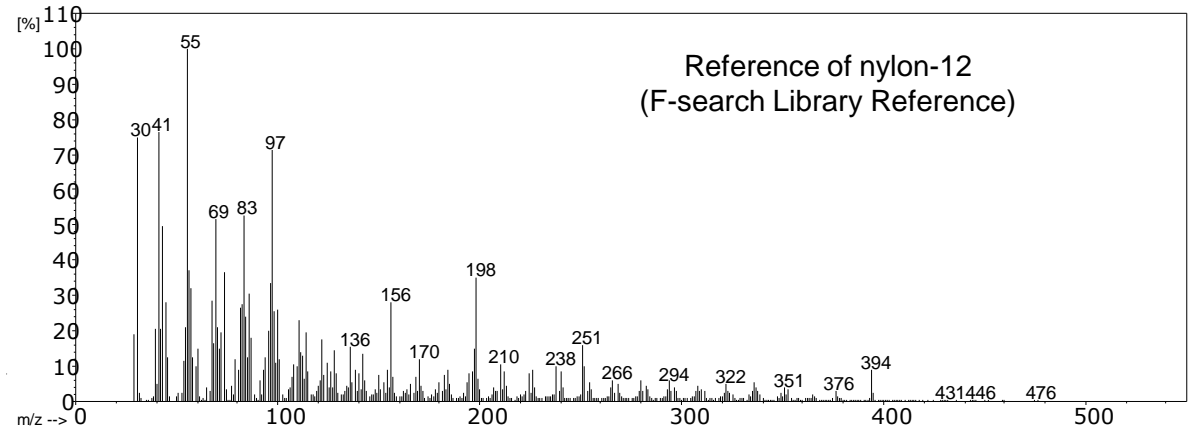
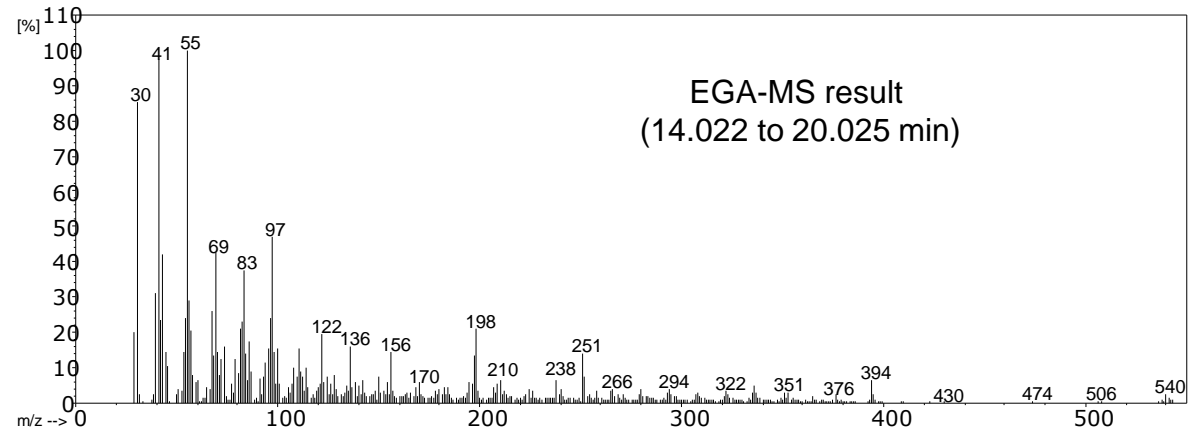
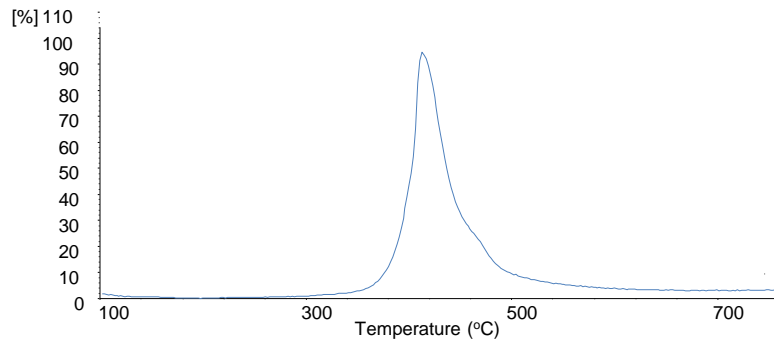

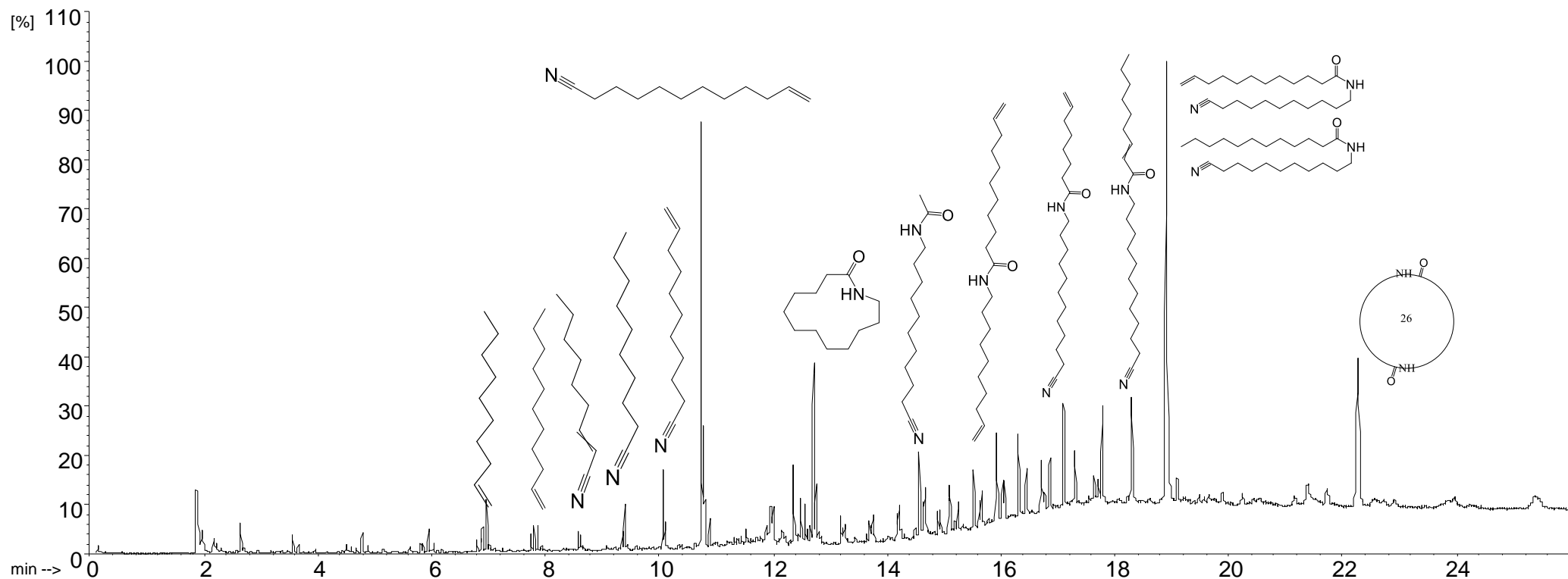

Single shot GC/MS result was analyzed by F-search compound library. A major peak of 11-dodecenenitrille is detected, demonstrating the length of alkyl chain. Another major peak stands for the mixture of two form of linear dimer of Nylon 12. A minor peak of cyclic Nylon 12 dimer was detected, which also supported the presence of Nylon 12.

# Polycarbonate (PC) Plastic Resins

**Background:** Polycarbonates (PC) are a group of thermoplastic polymers containing carbonate groups in their chemical structures. Polycarbonates used in engineering are strong, tough materials, and some grades are optically transparent. They are easily worked, molded, and thermoformed. Because of these properties, polycarbonates find many applications. Unlike most thermoplastics, polycarbonate can undergo large plastic deformations without cracking or breaking. As a result, it can be processed and formed at room temperature using sheet metal techniques, such as bending on a brake. Even for sharp angle bends with a tight radius, heating may not be necessary. This makes it valuable in prototyping applications where transparent or electrically non-conductive parts are needed, which cannot be made from sheet metal. This highly desirable engineering polymer material offers excellent chemical resistance and ductile properties suitable for various applications, even for 3D Printed objects and parts from filaments.

**Problem:** Although PC is a highly desirable resin, their properties and formulation chemistry vary with different formulators and manufacturers. While IR spectroscopy can be used for screening, it is not sufficient for composition determination or distinguishing the presence of PC resins or sources. The material used was a commercially available resin that is used for 3D Printing.

**Solution:** Perform EGA followed by a single shot analysis to confirm the presence of the PC or its other polymer contents and the general presence of other additives.



**Experimental:** About 100 µg of commercial PC filament was cut from a commercial PC filament to perform EGA from 100 to 800 °C (20 °C/min). The GC oven was kept isothermal at 320 °C. Flash pyrolysis technique was done using single shot mode at a 620 °C. The oven temperature is programmed to equilibrium at 40 °C for 2 min, increase to 320 °C by 20 °C/min and hold 320 °C for 10 minutes.

**Results:** The EGA thermogram demonstrated that the PC filament start to degrade at 320 °C and will be totally degraded at 600 °C. Library search is done by F-search, which fits well with the EGA-MS of sample, giving a result of good fitting with PC reference.

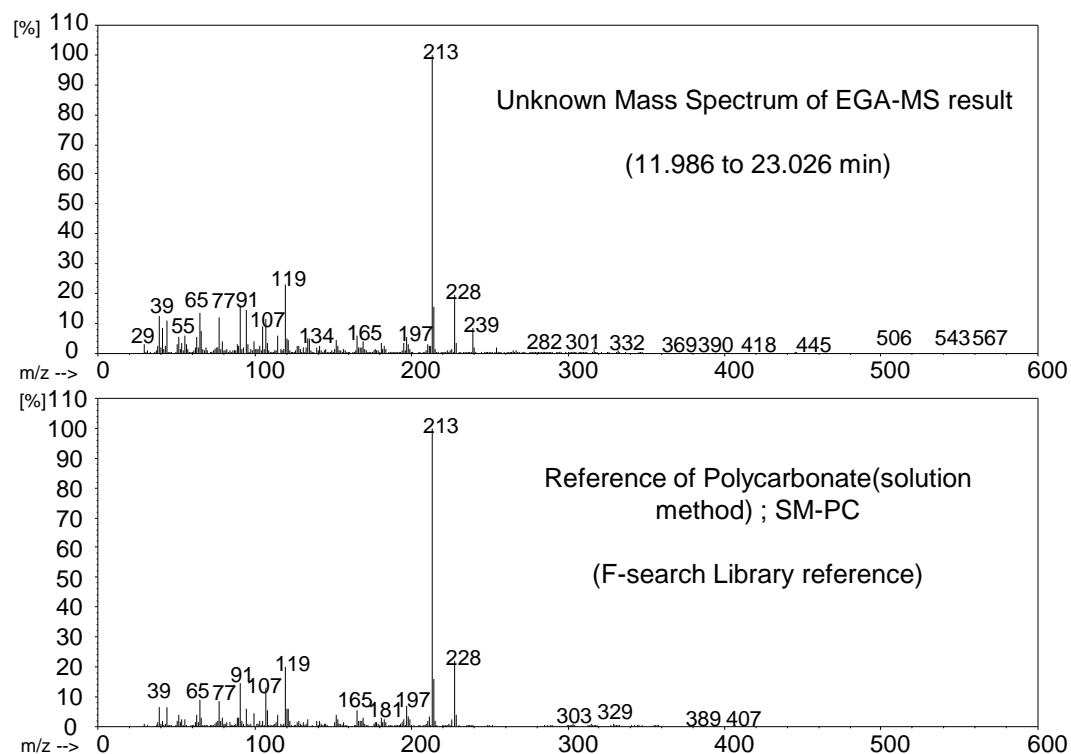
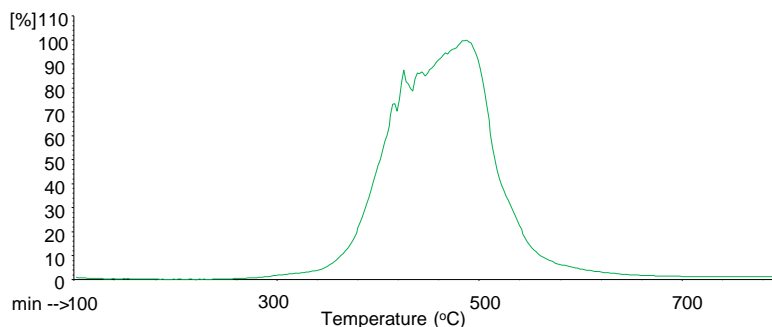

The single shot GC/MS was analyzed by F-search compound library. A major peak of bisphenol A is detected, demonstrating the breaking of ester bonds. Phenol, cresol and isopropylphenol were detected which demonstrate the C-C breaking at higher temperature. This result proves the presence of PC.

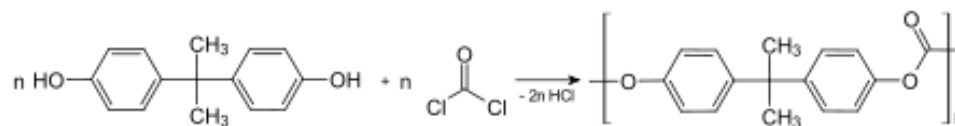
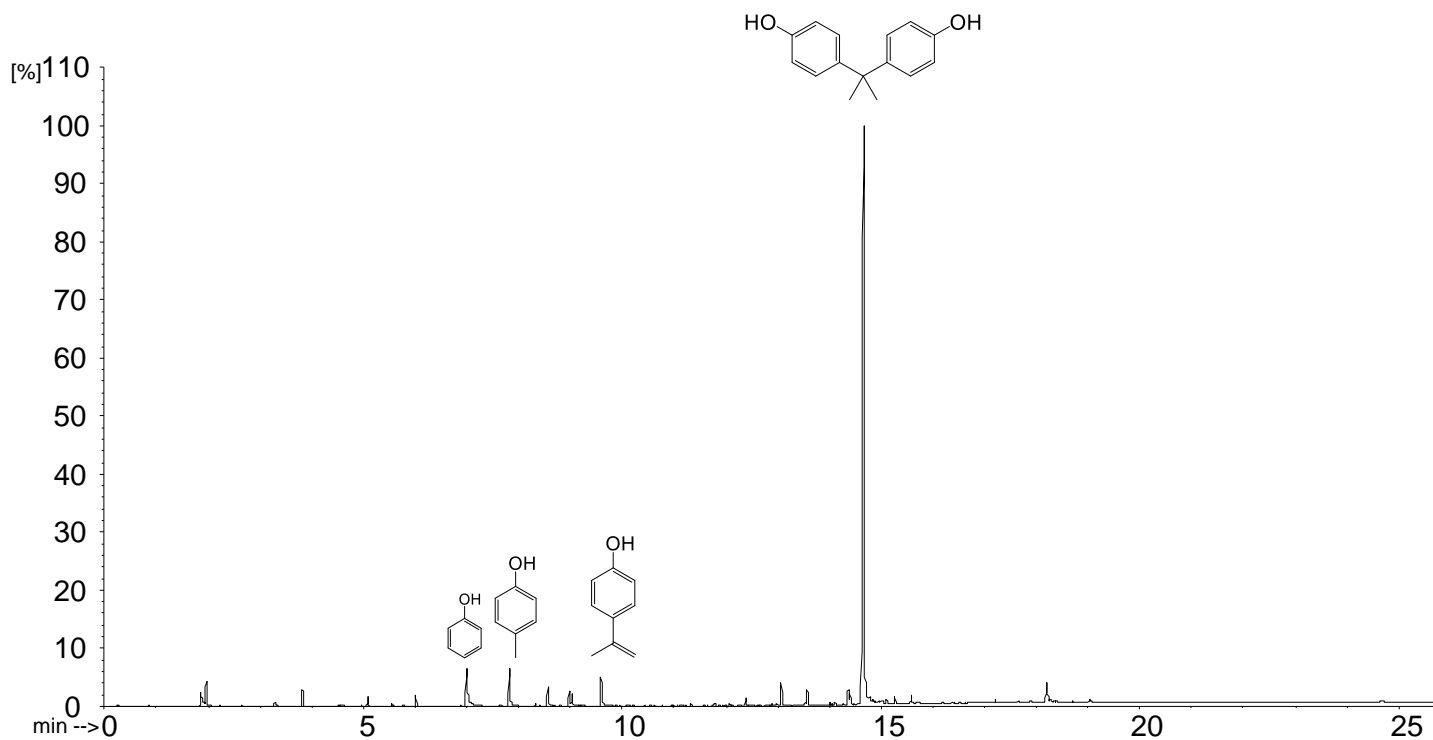



# Nylon 6 and Polyphenylene Sulfide (PPS) Polymer Blend

**Background:** Polyphenylene sulfide (PPS) is a high-performance polymer consisting of aromatic rings linked by sulfides. Synthetic fiber and textiles derived from this polymer resist chemical and thermal attack. PPS is used in filter fabric for coal boilers, papermaking felts, electrical insulation, film capacitors, specialty membranes, gaskets, and packings. However, PPS has the weakness of brittleness, low strain at break and low crystallization rate. Blending PPS with polyamide provides the advantage of increased toughness and impact strength.

**Problem:** Blending polymers can be sophisticated due to their difference in miscibility, structure and thermal property especially for high performance engineering plastics. Due to the high melting point of PPS, blending PPS with other low degradation temperature polymers can be challenging. To characterize the blended polymer, an accurate and reliable method is necessary. While IR spectroscopy be used for screening, it is not sufficient for composition determination or distinguishing the blended polymer. Microscope technology (AFM, SEM) can be used for characterization of uniformity, while sophisticated sample preparation and high-level operation skill is required.

**Solution:** Py-GC/MS provides the easiest way to characterize polymer blend of a targeted point on the sample, providing detailed composition information about the two polymers. Quantitative study is also available after calibration.

**Experimental:** EGA was performed to obtain a clear picture of the thermal profile of the 3D printed object. To perform EGA, around 100  $\mu\text{g}$  of an extruded Nylon6-PPS blend filament was cut from a 3D printed epoxy object and then placed in an Eco-Cup. The micro-furnace was then programmed from 100 to 800°C (20°C/min). The GC oven was kept isothermal at 320°C.

According to the EGA, the Hear-Cut technique were performed to slice the sample in two zones. Zone A: 360 °C-500 °C; zone B: 500 °C-700 °C.

Around 300  $\mu\text{g}$  of an extruded Nylon6-PPS blend filament was cut from the 3D printed object and placed in the Eco-Cup. Gas evolved in each zone was refocused by cryo-trap and injected separately. The oven temperature is programed to equilibrium at 40 °C for 2 min, increase to 320 °C by 20 °C/min and hold 320 °C for 10 minutes.

**Results:** According to the EGA result, two clear signal were detected. The first signal is dominated at the region of 360°C to 500°C, which may represent the degradation of Nylon 6. The second is located in between 500°C and 700°C, which may stand for the degradation of PPS. By utilizing the Heart-Cut technique, the two region can be separated and study independently.

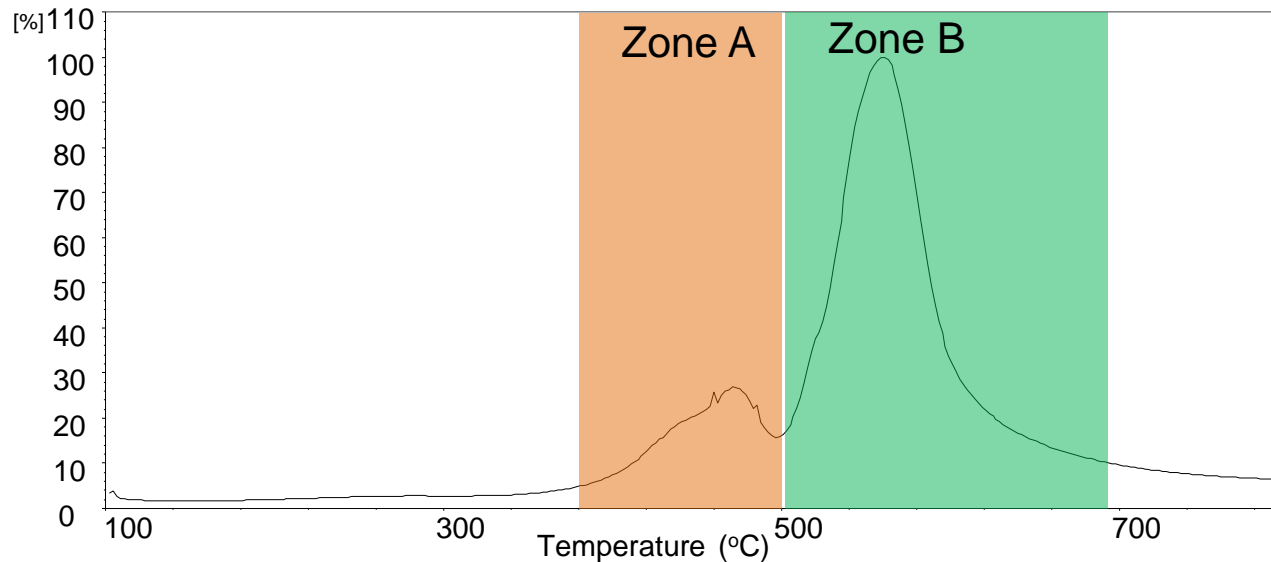

By separating zone A and zone B, the degradation of the two polymer can be studied separately. In zone A, a major peak of lactam is detected, which demonstrated this zone is mainly degradation of Nylon 6. Minor peak of N-(5-cyanopentyl)pent-4-enamide also supported that the region is dominated with Nylon 6.

In zone B, no lactam was detected, which suggested the Nylon 6 was completely degraded before 500°C. Benzenethiol, dimer PPS, trimer PPS and their isomers were detected as major peaks, which imply this zone is degradation of PPS.

These results demonstrated that Py-GC/MS is a powerful technique in studying polymer blend degradation.

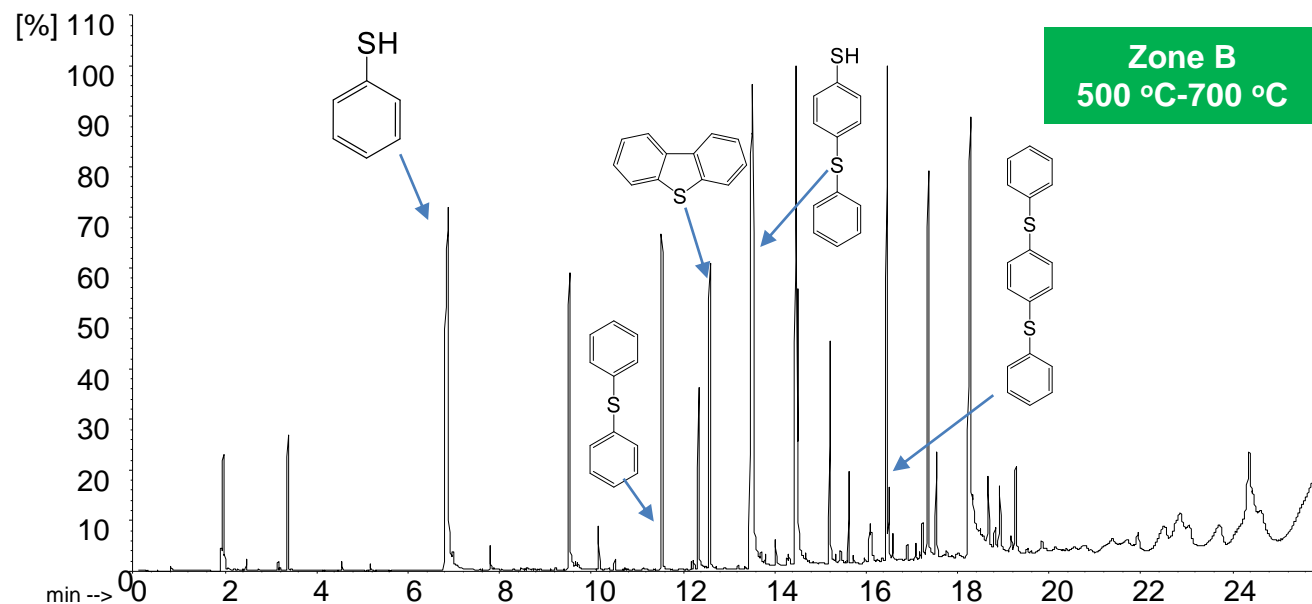
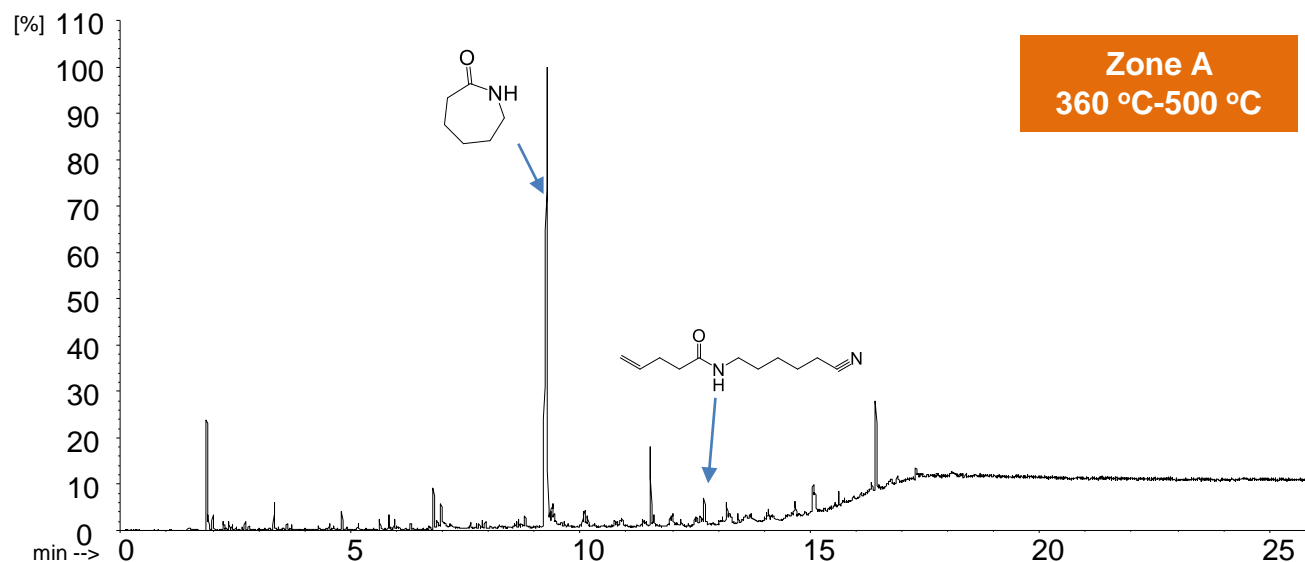

# Thermoset Polymer Resin Coated Proppant

**Background:** Proppant is solid particle material which is widely used in hydraulic fracturing to maintain a permeable channel to the well bore – a productivity tool. Typical proppant includes sands, treated sand and ceramics. Polymer resin coating technology increases the property of sand proppants in different kinds, such as productivity, long term stability, crush resistance and reduce flowback issue. These polymers can be made from phenol-formaldehyde, epoxy, polyurethane, etc. as thermosets. On the other hand, there is also high interest in using thermoplastic coatings for proppants.

**Problem:** Resin coating is a strong technique to improve the productivity and strength of proppant. However, techniques to characterize resin coated on proppant is limited by the nature of crosslinking. While IR spectroscopy or solid-state NMR be used for screening, it is not sufficient for composition determination or distinguishing the presence of additives

**Solution:** Utilize Pyrolysis-GC/MS to identify the resin and its additive of a commercial resin coated proppant. Compared to other technique such as TGA-IR and Solid-State NMR, Pyrolysis-GC/MS posses the advantages of no sample preparation required, easy to interpret and giving detailed information of additives.



## Experimental:

- 1) Evolved Gas Analysis (EGA) was performed first to obtain a clear picture of the thermal profile of the unknown resin coated sand. About 10 pieces of resin coated sand is placed in the sample cup and placed in the auto sampler. The micro-furnace was then programmed from 100 to 800°C (20°C/min). The GC oven was kept isothermal at 320°C. Compounds “evolved” from the sample as the temperature increases.
  
- 2) About 10 pieces of resin coated sand is added to the sample holder. A double shot technique (TD/PY-GC-MS) was programmed as follows:
  - For the thermal desorption, the temperature was set at 100 °C and increased to 300 °C by 20 °C/min. The oven temperature is programmed to equilibrium at 40 °C for 2 min, increase to 320°C by 20 °C/min and hold 320 °C for 10 minutes.
  - For the flash pyrolysis step, the temperature was set at 700 °C. The oven temperature is programmed to equilibrium at 40 °C for 2 min, increase to 320°C by 20 °C/min and hold 320 °C for 10 minutes.

**Result:** EGA technique show a rapid determination of the coating material. EGA mass spectrum was generated by summary the spectra from 0 min to 30 min. The obtained spectrum was identified to be phenol formadehyde by F-search libraries.

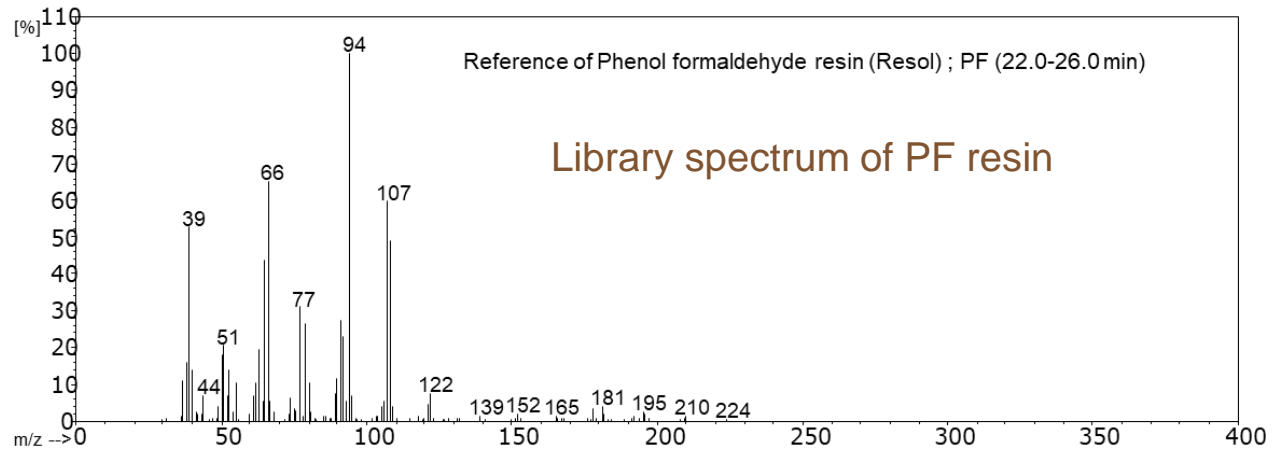
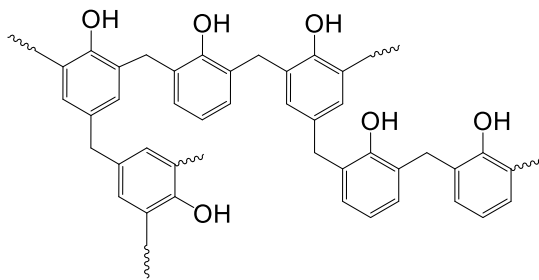
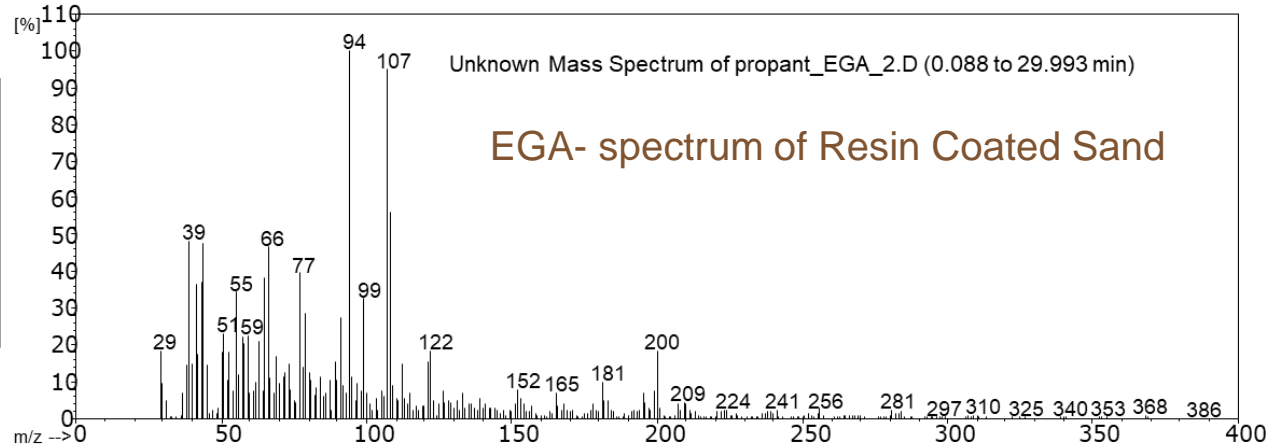
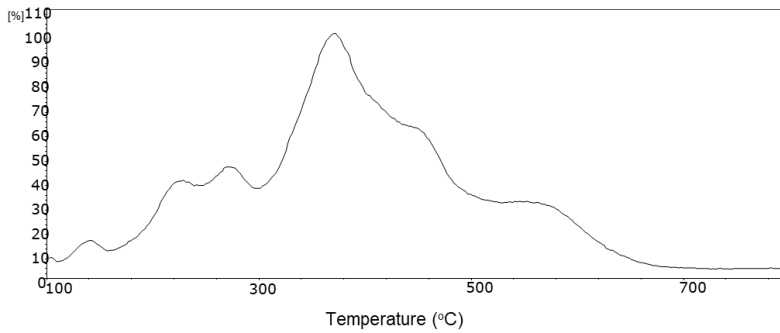

To study detailed information about the resin coated sand, Double shot technique was utilized. In the first step (TD) methylenediphenol and phenol were detected, which suggested the structure of phenol formadehyde.

Besides, isocynato-octane, palmitic acid were detected, which suggest that the use of emulsifier in PF resin preparation.

From the pyrogram, cresol and xylenol were detected, which supported the conclusion that the coating is PF resin.

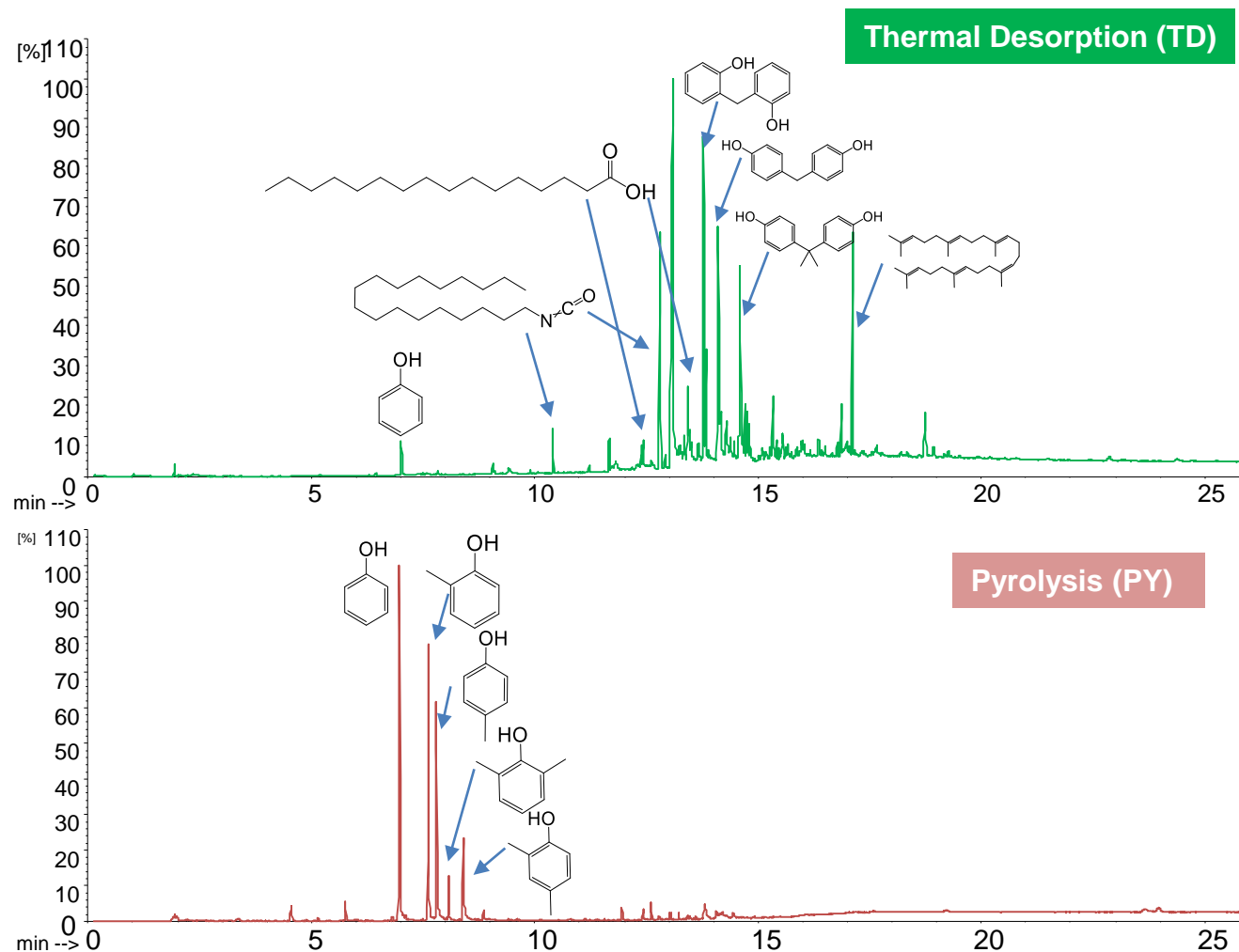

## What is Py-GC/MS Technique?

Pyrolysis GCMS is a powerful and straightforward technique that utilizes a Frontier Pyrolyzer as a programmable temperature inlet to a Gas Chromatography-Mass Spectrometer (GCMS) system. The material of interest (liquid or solid) is uniformly heated in an inert atmosphere. Volatile organics evolve at temperatures below 300 °C. At higher temperatures, covalent bonds break and the complex structure is degraded into smaller (stable and volatile) molecules which are referred to as pyrolyzates. The pyrolyzates formed and their relative intensities provide insight into the structure of the original material.

The Frontier Pyrolyzer is interfaced directly to the GC inlet. The sample is placed in a small deactivated inert cup which is, in turn, positioned in a micro-furnace. The temperature of the sample is carefully controlled ( $\pm 0.1$  °C) to ensure that the sample-to-sample thermal profile is identical. Frontier's well-engineered technology ensures that the sample is maintained at ambient temperature, in an inert atmosphere, prior to pyrolysis; thus eliminating evaporation, thermal degradation, and thermosetting before analysis.

The technical data in this monograph were obtained using one or more of the listed accessories. Each accessory is described in more detail in the system configuration section.

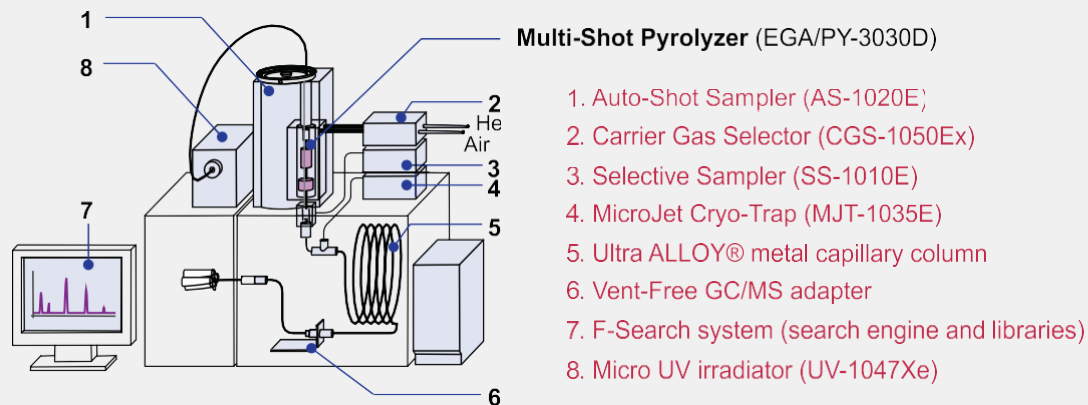



# Easy Sample Preparation

This technology allows multiple analysis on a single sample. There is no need for solvent and sample preparation as the sample is simply introduced into the GCMS by the Frontier Pyrolyzer.

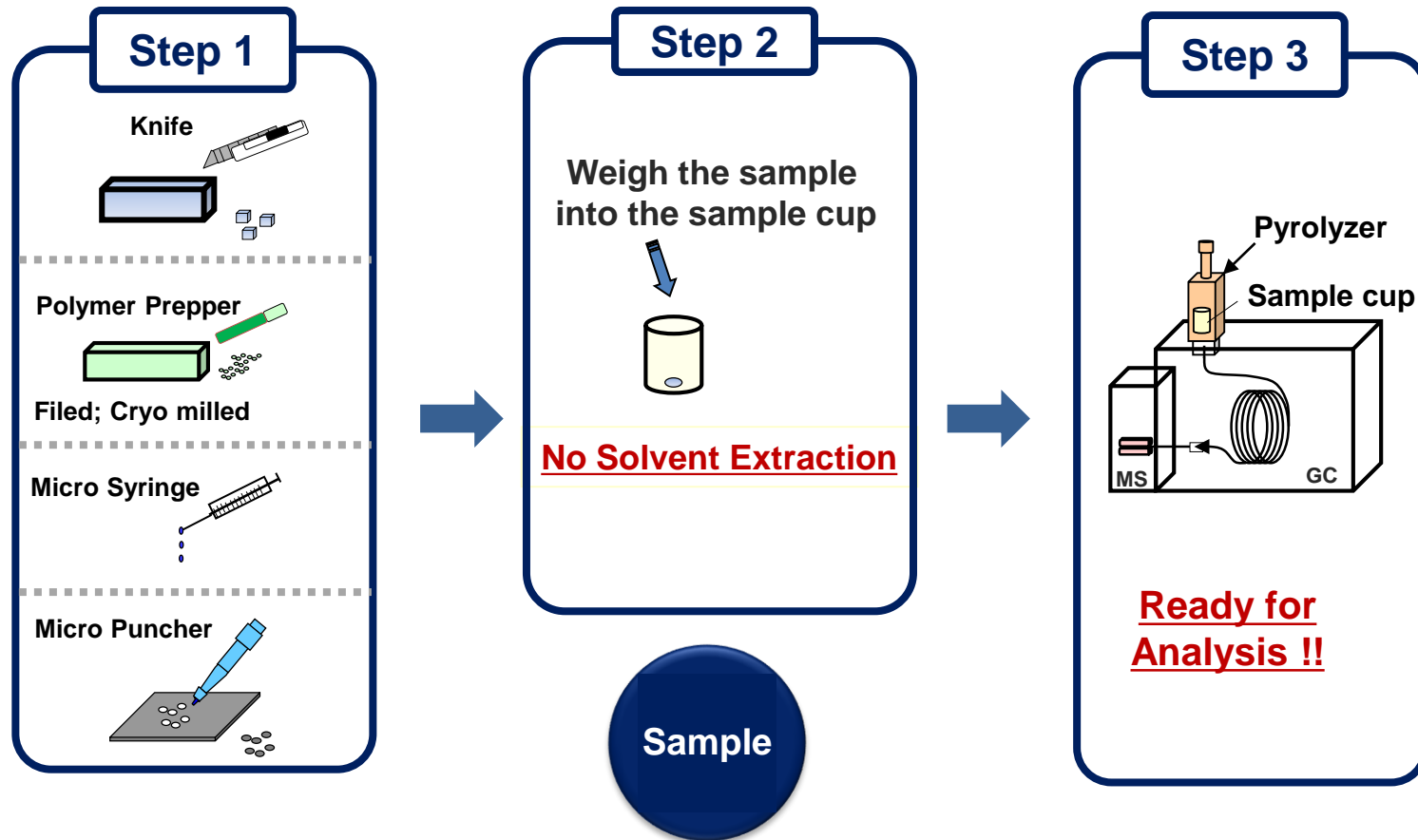

## F-Search Engine

### SIMPLIFYING AND IMPROVING THE ACCURACY OF DATA INTERPRETATION

Polymeric materials often contain a variety of additives such as antioxidants, UV absorbers, etc. to assist during the production phase and determine the physical and chemical characteristics of the final product.

These compounds are identified using commercial mass spectral (MS) libraries; however, these general-purpose MS libraries contain very few entries for pyrolyzates and additives which severely limits their utility for polymer characterization.

Frontier Laboratories developed a search engine and libraries called [F-Search](#). The ions associated with hundreds of polymers, their degradation products (i.e., pyrolyzates) and hundred of additives are used to identify and thus characterize the sample as it is heated in the Py.

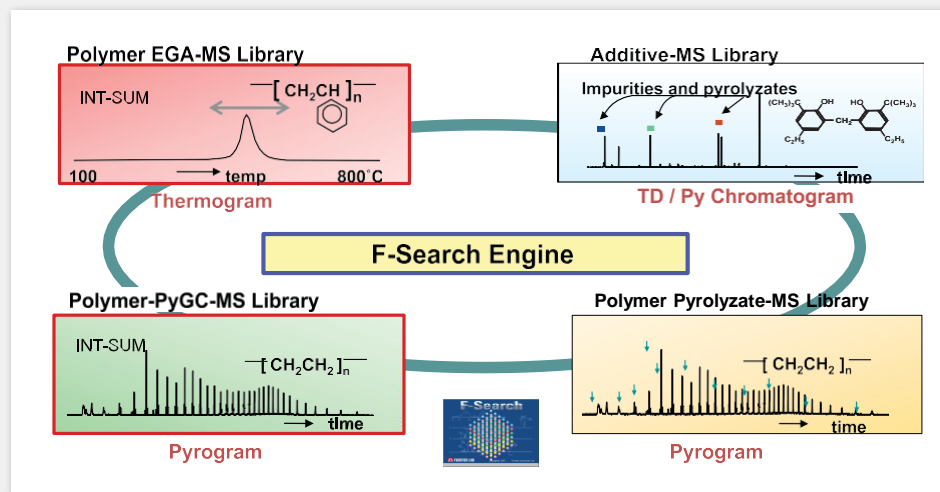

The libraries include both chromatographic and mass spectral data. There are four unique libraries which allow users to select among them for specific purposes. The ability to create in-house specialty libraries is incorporated into the standard software. Updating these libraries is straightforward.

## “Method Map” for Material Characterization

Frontier Lab has developed a sequence of tests referred to as the “method map” to chemically characterize samples using the EGA/PY-3030D Multi-Functional Pyrolyzer System in conjunction with a benchtop GC/MS. This sequence is applicable when characterizing virtually any organic material from volatiles to high molecular weight polymers.

The “**method map**” provides scientists with two simple steps for determining the organic composition of any unknown material:

- i. The first step is to perform an [Evolved Gas Analysis \(EGA\)](#). In this technique, the sample is dropped into the furnace which is at a relatively low temperature (ca. 40-100 °C). The furnace is then programmed to a much higher temperature (ca. 600-800 °C). Compounds “evolve” continuously from the sample as the temperature increases. A plot of detector response versus furnace temperature is obtained.

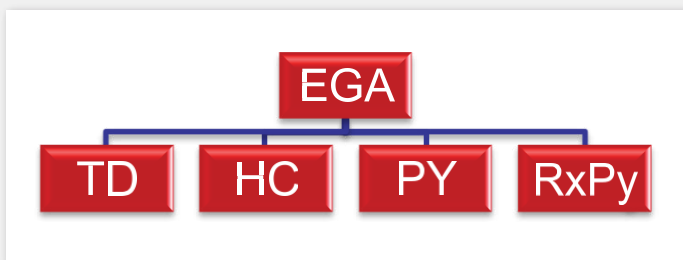

- ii. The second step is to use the EGA thermogram and selected ion chromatograms (EIC) to define the thermal zones of interest and then perform one or a combination of the following techniques:

*Use the links below for more information.*

[Thermal Desorption \(TD\)](#)

[Flash Pyrolysis \(Py\)](#)

[Heart Cutting \(HC\)](#)

[Reactive Pyrolysis \(RxPy\)](#)

## EGA & “Method Map”

**EGA Configuration:** No column is used; a short, small diameter (1.5m X 0.15mm id) deactivated tube connects the injection port to the detector. All thermal zones (interface temperature, GC injection port, column oven and detector cross-over) are held at elevated temperatures to prevent condensation. The figure below shows the EGA-MS configuration and a typical EGA thermogram.

Following EGA, the instrument is re-configured. The EGA tube is replaced by an analytical column. The Frontier [Vent-Free Adaptor](#) enables this to be done easily and quickly; there is no need to vent the MS. MS vacuum equilibrium is re-established within a few minutes, and the exposure of the ion source to oxygen is minimized.

In this example, a double-shot analysis (TD of the thermally stable and the volatile components followed by Py of the residual sample in the cup) was performed to characterize the two thermal zones shown on the EGA thermogram. One sample is analyzed two times; the sequence is fully automated.

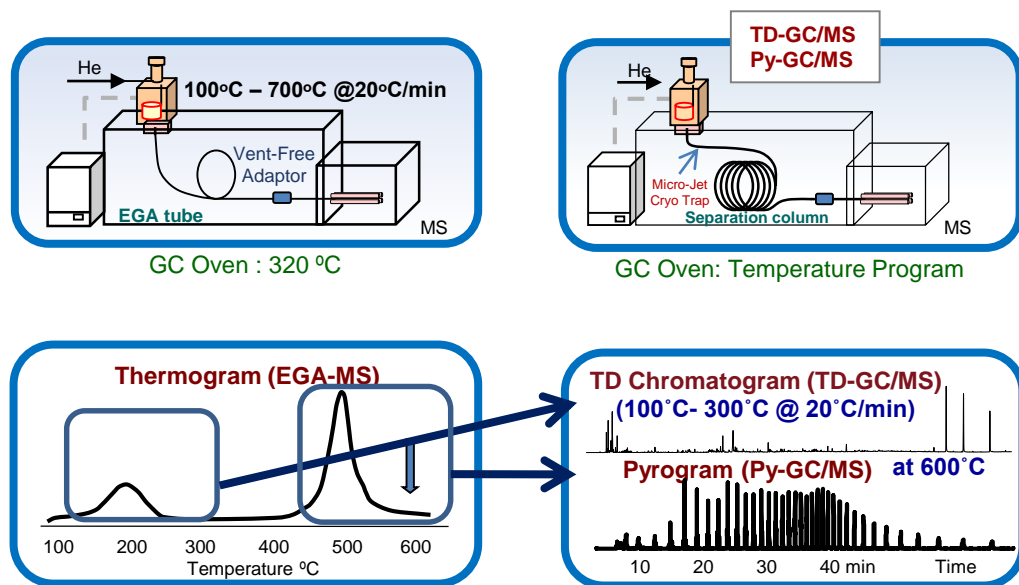

As shown in the Figure, information about the organic ‘volatiles’ in the sample is generated by simply introducing the sample at 300 °C, only the compounds evolving below 300 °C will evolve from the sample and be transported to the head of the column. If there is interest in both the volatile fraction and the higher boiling compounds, this can be done in two steps, and it may be necessary to add a micro-cryo trap. Thermal desorption is performed over time, e.g., 100 to 250 °C at 20 °C /min takes 7.5 minutes. The micro-cryo trap re-focuses the volatile analytes of interest at the head of the column so that the full separating power of the column can be utilized.

If there are more than two zones in the obtained EGA thermogram, Heart-cutting (HC) technique, which utilizes an accessory called a [Selective Sampler](#), slices the thermal zones out of the sample and separate the components chromatographically with detection by MS.

# Py-GC/MS System Configuration

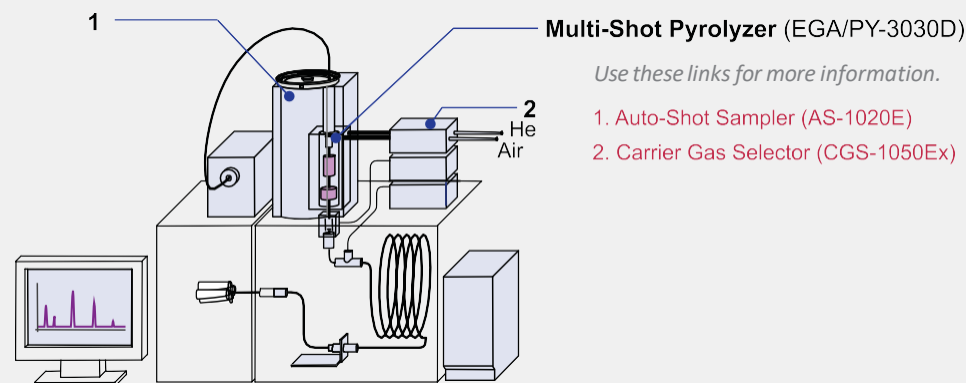

## 1. Auto-Shot Sampler (AS-1020E)

Up to 48 samples can be automatically analyzed using any of the analytical modes (e.g., TD, Py, Double-Shot, Heart-Cutting. Etc) with enhanced reliability.



Pyrolyzer is located in the housing of Auto-Shot Sampler.

## 2. Carrier Gas Selector (CGS-1050Ex)

The device allows switching of the gas, e.g., He and air, surrounding the sample during analysis.

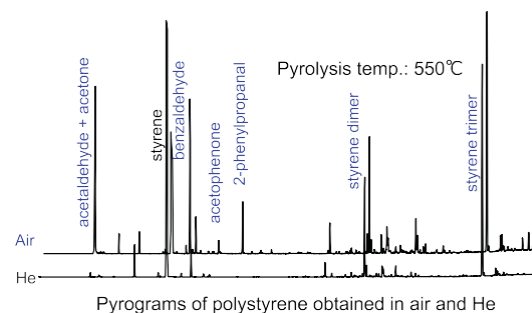

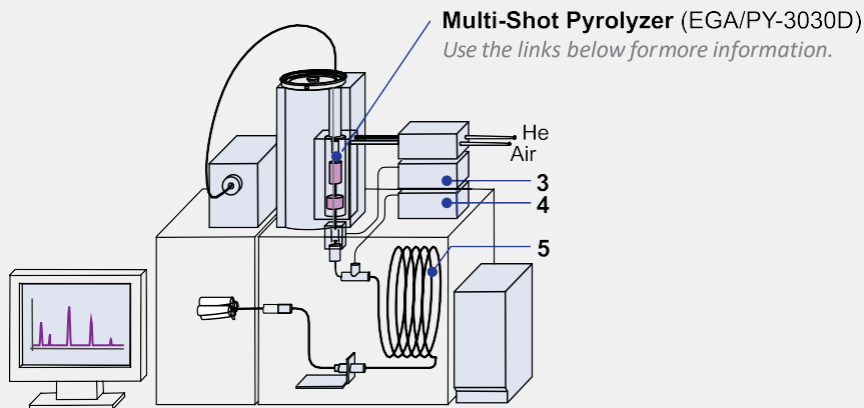

- 3. Selective Sampler (SS-1010E)
- 4. MicroJet Cryo-Trap (MJT-1035E)
- 5. Ultra ALLOY® metal capillary column

### 3. Selective Sampler (SS-1010E)

Any temperature zone as defined by the EGA thermogram, that is Heart-Cutting either manually or automatically, can be introduced to a separation column.

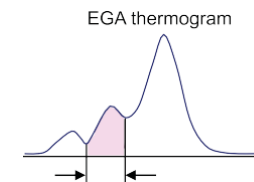

Any temperature zone can be heart-cut for GC/MS analysis.

### 4. MicroJet Cryo-Trap (MJT-1035E)

By blowing liquid nitrogen jet to the front of separation column, volatile compounds are cryo-trapped while maintaining the temperature at  $-196^{\circ}\text{C}$  using only one third of the amount of liquid nitrogen required for competitors products. It supports automated analysis.

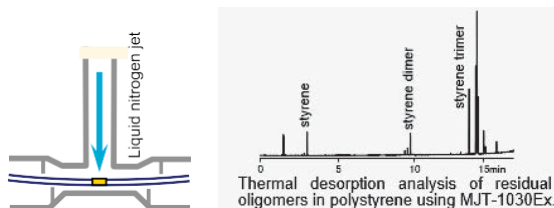

### 5. Ultra ALLOY® Metal Capillary Column

By multi-layer gradient deactivation treatment, these separation columns have high flexibility, high temperature, and contamination resistances.

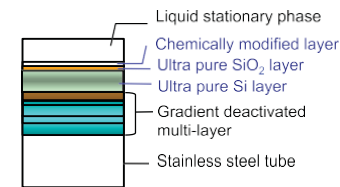
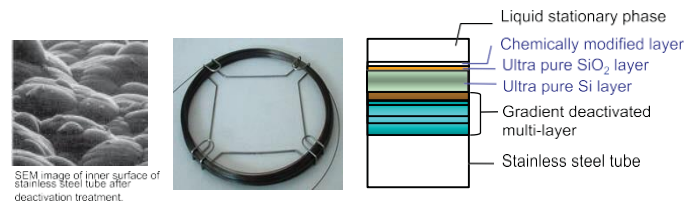

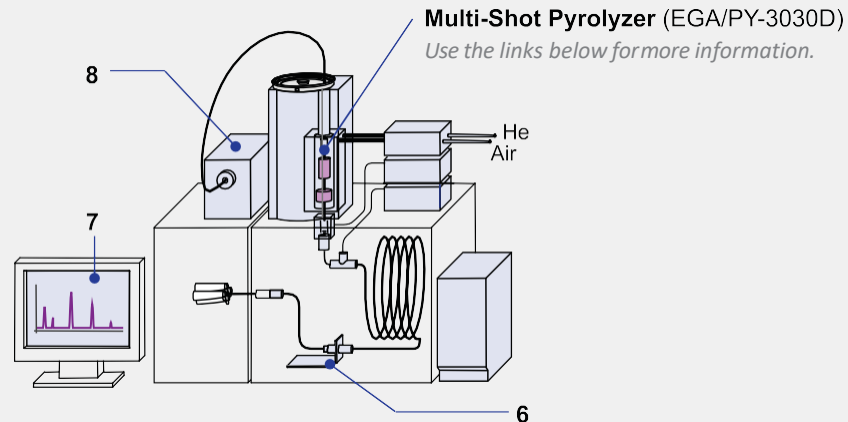

- 6. Vent-Free GC/MS adapter
- 7. F-Search system (search engine and libraries)
- 8. Micro UV irradiator (UV-1047Xe)

## 6. Vent-free GC/MS Adapter

Without venting MS, separation column and/or EGA tube can be switched.

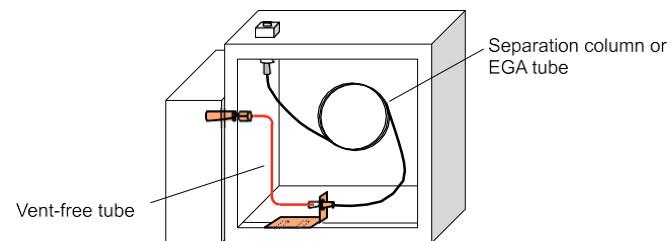

## 7. F-Search System (Libraries and Search Engine)

This software system supports identification of polymers and additives from data obtained by evolved gas analysis, thermal desorption, or pyrolysis GC/MS analysis.

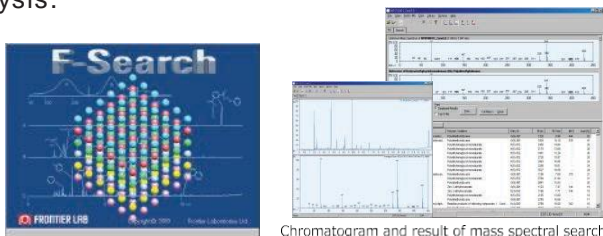

Chromatogram and result of mass spectral search

## 8. Micro-UV Irradiator (UV-1047Xe)

With a strong Xe UV light source, photo, thermal, and oxidative degradation of polymers can rapidly be evaluated.

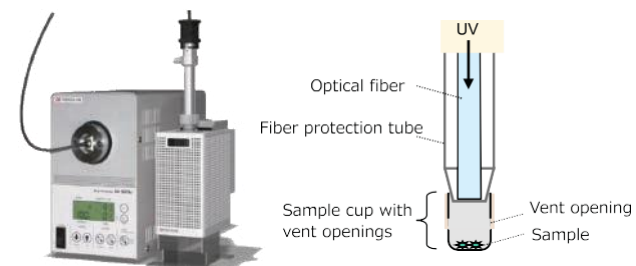

## PLEASE VISIT OUR WEB SITE FOR OTHER APPLICATION AREAS

Visit Frontier Lab web site at [www.frontier-lab.com](http://www.frontier-lab.com) to find more materials categorized by the following application areas:

- ADDITIVES** ..... PLASTICIZERS, RELEASING AGENTS, SURFACTANTS, RESIDUAL MONOMERS, SOLVENTS, VOLATILES, IMPURITIES
- ADHESIVES**..... ACRYLICS, EPOXY, THERMOPLASTIC, ANAEROBIC
- COATINGS** .....PIGMENTS, DYES, SOLVENTS, DRIERS, FILM FORMERS
- CONSUMER PRODUCTS** ..... TEXTILES, PERSONAL CARE PRODUCTS, PACKAGING, TOBACCO, FIBERS
- ELASTOMERS** ..... NATURAL SYNTHETIC RUBBERS, SILICONES, SULFUR COMPOUNDS
- ENERGY** .....BIOMASS, OILS, COAL, HYDROCARBONS, GEOCHEMISTRY, BIOCHEMISTRY
- ENVIRONMENTAL** .....VOLATILES, POLLUTANTS, PESTICIDES
- FORENSIC AND SECURITY**..... FORENSIC EVIDENCES
- INKS AND PAINTS** .....PIGMENT, RESIN, SOLVENT, DEFOAMER, WAX, PHOTOCOPY TONER
- PAPER AND FIBERS** ..... WOODS, PULP, COATINGS, SIZING AGENTS
- POLYMER PROCESSING** ..... POLYMER CHARACTERIZATION TECHNIQUES
- OTHERS** .....MISCELLANEOUS APPLICATIONS





Connect with us!  

---

### OUR OFFICE LOCATIONS

**Japan (Headquarters)**  
**North America (Houston, TX)**  
**Europe (Germany)**  
**SEA/Oceania (Singapore)**  
**India (Bangalore)**  
**China (Beijing)**  
**Russia (Moscow)**

---

### TECHNICAL EXPERTS CONTACT INFORMATION

#### **Japan**

4-16-20 Saikon, Koriyama  
Fukushima, 963-8862 JAPAN  
+81-24-935-5100

*To connect with a technical expert in your region:*  
[www.frontier-lab.com/english/business-partners/](http://www.frontier-lab.com/english/business-partners/)